

Product catalogue 2025



TEKLAB specializes in providing modular and multipurpose electric workstations and laboratories for education and industry.

Our solutions are used for example in following areas:

EDUCATIONAL

- Electronics laboratories
- Electrical engineering laboratories
- Physics laboratories
- Calibration laboratories
- ICT laboratories
- Aviation laboratories
- Automotive laboratories
- Industrial training centres
- STEM laboratories

More than 25 000 TEKLAB workstations have been delivered to more than 130 countries during our 40 years of existence. Thus, our experience provides us leading knowledge of customer requirements in demanding industrial and educational environments.

TEKLAB is world widely well known as a reliable partner with longlife quality test benches. We are committed to support our customers and partners by providing industry-leading expertise with complete service all the way from product development to turn-key delivery.

All specifications in the catalogue are subject to change without notice.

INDUSTRIAL

- Electrical industry
- Electronics industry
- Process industry
- Defence
- Pharmaceutical
- Marine
- Food & beverage

Teklab's long experience as an Industrial Workshop supplier has made us a reliable partner in project deliveries.

Our project delivery includes e.g.

- 3D layout design for workshops
- Specifications and deliveries of workstations, industrial furniture and necessary equipment
- Calibration certificates
- User manuals in the desired language
- Data entry into the customer's system
- Installation, training, maintenance and spare part services
- **Electrical safety tests**

TEKLAB products are Finnish quality work. Our factory is located in Loviisa, Finland.

Contact us when you need a responsible partner for your projects.



TABLE OF CONTENTS

Workstations.....	5
Accessories and fittings.....	14
Supply units.....	23
Variable DC power supplies	25
Fixed DC power supplies.....	29
1 phase AC power supplies.....	30
3 phase AC power supplies.....	32
1 phase AC connections.....	35
3 phase AC connections.....	36
Connections	37
Multimeters	40
LCR meters.....	43
Function generators.....	44
Oscilloscopes.....	47
Power analyzers.....	48
Calibration equipment	49
Test equipment.....	54
Soldering equipment.....	56
Laboratory examples	62
Laboratory softwares	64
Other laboratory products.....	66
Workstations for EP modules.....	70
EP modules	73

Trolleys

MOBILELAB



MOBILELAB4



MOBILELAB3



MOBILELAB2500

Trolleys offer great mobility for a large number of integrated devices. Trolleys can be equipped with stands and cabinets for creating a practical mobile workplace

- ESD powder painted steel construction
- 4 wheels, diameter 80 mm, two with brakes
- Handle for easy moving of the trolley
- Built-in device panel for integrated electrical equipment
- Device panel is modular: devices can be easily added and removed
- Integrated modules are covered with polyester film to ensure long lifetime for the markings in the front panel
- 2 pcs sockets at the back
- Perforated upright tubes for fastening accessories to different heights
- Versatile and adjustable accessories enable ergonomic and practical working environment
- MOBILELAB2 includes bottom shelf and, MOBILELAB3 upper shelf
- ESD mats on top of the surfaces
- Dimensions: 780(W) x 720(D) x 1630(H) mm
- Dimensions: 593(W) x 720(D) x 1630(H) mm (MOBILELABx500 models)

Models	Description/width mm	Full modules max
MOBILELAB4	Electric trolley, 4 levels, 780 mm	11
MOBILELAB3	Electric trolley, 3 levels, 780 mm	8 ¼
MOBILELAB2	Electric trolley, 2 levels, 780 mm	5 ½
MOBILELAB4500	Electric trolley, 4 levels, 593 mm	8
MOBILELAB3500	Electric trolley, 3 levels, 593 mm	6
MOBILELAB2500	Electric trolley, 2 levels, 593 mm	4
Options	Description	
MOBILELABSUK	2 pcs UK sockets	
MOBILELABSUS	2 pcs US sockets	
MOBILELABBH	Holder for compressed air bottle	
WPT861511	Perforated back panel, 718 x 389 mm (for 780 mm models)	
WVK821465	Perforated tool cabinet, 720 x 255 x 300 mm (for 780 mm models)	

CONCEPT TOWER

TABCONH, TABCONCH, PANCONH



The Tower Concept workstations has 1500, 1800 and 2000 mm wide and 900 mm deep models. Available with electronic height adjustment. Corner workstation also available.

The high upright tube frame enables a versatile range of accessories, that can be installed above the table top and also above the equipment panel, e.g. LED work light, shelves, perforated back panels etc.

The panel's power- data- and other connections are easily usable under the panel and the tables can be placed back to back or against a wall.

- Workstation frame
 - ESD-painted stable steel frame
 - L-shaped ergonomic legs, stepless adjustable between 670-1100 mm
 - Height of the upright tube module 1300 mm from table top
 - Versatile and adjustable accessories enable ergonomic and practical working environment
 - Load capacity manually adjustment 500 kg, electrical model 400 kg, evenly loaded
 - Adjustment screws to eliminate the roughness of the floor
 - Table top with laminate surface, durable rounded plastic edges, colour light speckled grey
 - The core of the optional ESD-table top, as well as the laminate of the coating are semi-conductive
- Device panel
 - Panel for integrated electrical equipment
 - Structure of the panel made of ESD powder painted steel
 - Panel equipped with modular device system: devices can be easily added and removed
 - Integrated modules are covered with polyester film to ensure long lifetime for the markings in the front panel
 - Energy saving LED lighting integrated at the bottom of the panel
 - Panel top can be opened
 - Height from the table top can be freely chosen
 - All connectors are located at the bottom of the panel, which enables placing the panel against a wall

Workstation frames, standard table top	Workstation frames, ESD table top	Table top size, W x D (mm)
TABCONH15, TABCONH15E	ETABCONH15, ETABCONH15E	1530 x 900
TABCONH18, TABCONH18E	ETABCONH18, ETABCONH18E	1830 x 900
TABCONH20, TABCONH20E	ETABCONH20, ETABCONH20E	2030 x 900
TABCONCH10	ETABCONCH10	Corner workstation
E = Electrical height adjustment		
Panels	Full modules max.	Panel width (mm)
PANCONH15	6	1530
PANCONH18	7 ¼	1830
PANCONH20	8	2030
PANCONCH10	3 ½	Corner panel
Options for Concept Tower panel		Description
PANSOCKETLEU		2 x 2 pcs schuko sockets under device panel
PANSOCKETLUK		2 x 2 pcs UK sockets under device panel
PANSOCKETLUS		2 x 2 pcs US sockets under device panel

Electrically / manually adjustable Concept high workstation

TABSYSH/E, TABCONCH, PANCONH



An easy way to adapt one workstation for several users is to have it equipped with manual and electrical height adjustment. At the same time, electrical height adjustment enables the workstation to be suitable for standing work – ergonomics at its best.

- Workstation frame
 - ESD powder painted stable steel frame
 - Table top with laminate surface, durable rounded plastic edges, colour light speckled grey
 - Optional ESD-table top
 - Electrically adjustable height: 700 – 1100 mm, manually adjustable height: 670 – 1120 mm
 - Frame includes uprights for the device panel and perforated backplates between the uprights
 - Accessories are attached to perforated uprights and can be positioned to suit individual needs
 - Versatile and adjustable accessories facilitate ergonomic component storage and selection
 - Adjustment screws to eliminate the roughness of the floor
 - Load capacity manually adjustment 500 kg, electrical model 400 kg, evenly loaded
- Device panel
 - Panel for integrated electrical equipment
 - Structure of the panel made of ESD powder painted steel
 - Panel equipped with modular device system: Devices can be easily added and removed
 - Integrated modules are covered with polyester film to ensure long lifetime for the markings in the front panel
 - Energy saving LED lighting integrated at the bottom of the panel
 - Panel top can be opened
 - Height from the table top can be chosen between 370, 425 or 480 mm

Workstation frames, standard table top	Workstation frames, ESD table top	Table top size, W x D (mm)
TABSYSH15, TABSYSH15E	ETABSYSH15, ETABSYSH15E	1530 x 900
TABSYSH18, TABSYSH18E	ETABSYSH18, ETABSYSH18E	1830 x 900
TABSYSH20, TABSYSH20E	ETABSYSH20, ETABSYSH20E	2030 x 900
TABCONCH10	ETABCONCH10	Corner workstation
E = Electrical height adjustment		
Panels	Full modules max.	Panel length (mm)
PANCONH15	6	1530
PANCONH18	7 ¼	1830
PANCONH20	8	2030
PANCONCH10	3 ½	Corner panel
Options for Concept workstations	Description	
PANSOCKETLEU	2 x 2 pcs schuko sockets under device panel	
PANSOCKETLUK	2 x 2 pcs UK sockets under device panel	
PANSOCKETLUS	2 x 2 pcs US sockets under device panel	

Heavy duty workstation

TABHEAVYH, PANCONH



This model is designed to withstand heavy-duty use. It is equipped with an extra thick table top and a strong steel frame. Also this model can be customized with a wide range of accessories.

- Workstation frame
 - ESD powder painted steel frame
 - Four legs
 - Three spacer bars / supports between legs for stable construction
 - Frame includes uprights for the device panel and perforated backplates between the uprights
 - Accessories above the table top are attached to perforated uprights and can be positioned to suit individual needs
 - Versatile and adjustable accessories facilitate ergonomic component storage and selection
 - The tabletop has a core of plywood and chipboard, grey vinyl surface and plastic edges, thickness 50 mm
 - Adjustable height: 750-1000 mm
 - Table can be fastened to floor
 - Load capacity 500 kg, evenly loaded
- Device panel
 - Panel for integrated electrical equipment
 - Structure of the panel made of ESD powder painted steel
 - Panel equipped with modular device system: Devices can be easily added and removed
 - Integrated modules are covered with polyester film to ensure long lifetime for the markings in the front panel
 - Energy saving LED lighting integrated at the bottom of the panel
 - Panel top can be opened
 - Height from the table top can be chosen between 370, 425 or 480 mm

Workstation frames, standard table top	Table top size, W x D (mm)
TABHEAVYH15	1500 x 750
TABHEAVYH20	2000 x 750

Panels	Full modules max.	Panel length (mm)
PANCONH15	6	1530
PANCONH20	8	2030

Options for Concept workstations	Description
PANSOCKETLEU	2 x 2 pcs schuko sockets under device panel
PANSOCKETLUK	2 x 2 pcs UK sockets under device panel
PANSOCKETLUS	2 x 2 pcs US sockets under device panel

Concept workstation

TABSYSL, PANCONL



Concept workstation is a good solution for rooms where it is preferred to have a direct view forward, or to allow natural light to enter the space. The top of the panel can be used as a practical plane surface.

- Workstation frame
 - ESD powder painted steel frame
 - L-shaped ergonomic legs
 - Table top with laminate surface, durable rounded plastic edges, colour light speckled grey
 - Core of the ESD-table top, as well as the laminate of the coating are semi-conductive
 - Adjustable height: 670 - 1120 mm
 - Adjustment screws to eliminate the roughness of the floor
 - Load capacity 500 kg, evenly loaded
- Device panel
 - Panel for integrated electrical equipment
 - Installed on the table top
 - Structure of the panel made of ESD powder painted steel
 - Panel equipped with modular device system: devices can be easily added and removed
 - Integrated modules are covered with polyester film to ensure long lifetime for the markings in the front panel
 - Panel top can be opened
 - All connectors are located at the bottom of the panel which enables placing the panel against a wall

Workstation frames, standard table top	Workstation frames, ESD table top	Table top size, W x D (mm)
TABSYSL15	ETABSYSL15	1530 x 900
TABSYSL18	ETABSYSL18	1836 x 900
TABSYSL20	ETABSYSL20	2030 x 900

Panels	Full modules max.	Panel length (mm)
PANCONL15	6	1530
PANCONL18	7 ¼	1836
PANCONL20	8	2030

Multipurpose workstation

HELP3



TEKLAB HELP3 workstation is based on a unique multipurpose construction, which enables theory lessons and practical training in one room.

HELP3 workstations are an excellent solution for basic electrical engineering laboratories, physics laboratories as well as for teaching the basics of electrical systems to ICT and car technicians and engineers.

HELP3 multifunction workstation is a cost-effective solution for training laboratories. Thanks to the compact size, the laboratory can be built into rooms with limited space.

- Multipurpose construction: electric workstation and theory desk in one solution
- Built-in instrument panel for integrated electrical instruments, instrument panel located under a sliding table top
- Sliding table top movable forwards and backwards to enable / hide the instrument panel
- Sliding table top can be locked to prevent access to the instrument panel
- Modular instrument panel:
 - Devices can be added afterwards
 - Instrument panel is slanted to achieve best possible usability
 - Integrated modules are covered with polyester film to ensure long lifetime for the markings in the front panel
- Workstation frame and instrument panel made of ESD powder painted steel
- L-shaped ergonomic legs for more space under workstation
- Adjustable height 710-780 mm
- Adjustment screws under the workstation to eliminate the roughness of the floor
- Table top with laminate coating, durable plastic edges, colour light grey
- 4 pcs sockets in the energy channel located at the rear part of the workstations. Sockets are available also when the table top is in closed position.
- Can be equipped with upright tubes for fixing accessories such as shelves, display holders or frames for training panels

Workstation frames	Workstation size, W x D (mm) Top open/close	Table top size W x D (mm)	Full modules max.
HELP3L12	1210 x 580-810	1210 x 508	4 ½
HELP3L15	1460 x 580-810	1460 x 508	5 ½
HELP3L17	1710 x 580-810	1710 x 508	6 ½

Options for HELP3 workstations	
LOCK3M	Manual lock for cover
LOCK3EL	LAN-controlled electric lock for cover
WKS820717	Mini cabinet under the table top, lockable, dimensions: 255(W) x 330(D) x 189(H) mm
HELP3SOCKEU	4 pcs schuko sockets under the workstation
HELP3SOCKUK	4 pcs UK sockets under the workstation
HELP3SOCKUS	4 pcs US sockets under the workstation

Multipurpose workstation

HELP6



HELP6L20 device panel + storage space available



HELP6L20D double panel



HELP6 device panel available



HELP6 flat work surface

HELP6 motorised workstation is the right choice e.g. for electronics and electric training laboratories. Considerable savings are achieved thanks to the possibility to modify classrooms for different purposes. Valuable storing space is also saved when laboratory equipment, components and training kits are available in the integrated storage unit. Together with TLMC laboratory control software, HELP6 workstations convert the laboratory into a multifunctional room.

- Multipurpose construction: electric workstation and theory desk in one solution
- Construction includes a fixed table section (2000 x 600 mm) in the front and a motorized panel section (2000 x 525 mm) in the rear
- Motorized panel section includes a built-in device panel for integrated electrical equipment and a storage unit below it
 - Device panel is modular: devices can be added later on.
 - Storage space is suitable for storing training kits, motors, soldering equipment etc.. Storage space dimensions: 1800(W) x 440(D) x 300(H) mm, Motorized panel equipped with fast, silent and service free electric motors for moving panel up / down
- Motorized panel can be used in three positions: down (flat work surface), middle (device panel available), up (device panel + storage space available)
 - While panel is down, devices and equipment are safe from unauthorized use
 - Panel can be driven either using a manual controller, or using laboratory control software
 - Safety switch between the motorised panel and workstation frame for finger protection
 - Workstation frame made of ESD painted steel
 - L-shaped ergonomic legs in the front
 - Table tops with laminate surface, durable rounded plastic edges, colour light speckled grey
 - Load capacity for workstation: 250 kg
 - Adjustment screws to eliminate the roughness of the floor
 - Can be connected to LAN and used with TLMC software (optional)

Workstation frames, standard table top	Workstation frames, ESD table top	Table top size, W x D (mm)	Full modules, max.
HELP6L20, HELP6L20D	EHELP6L20, EHELP6L20D	2000 x 1125	7 ¼ / 14 ½
Options for HELP6L20/HELP6L20D workstations			
HELP6CM / HELP6CB	HELP6 control module or LAN module (needs for each workstation) 125 mm module		
HELP6SOCKET / -UK, -US	Integrated sockets for panel top (European schuko / UK/US type)		
HELP6FRSOCKET	2 x 2 pcs extra sockets under table top		
HELP6RACK	Rack for fume extraction system		
Options for HELP6L20 workstation			
PANSOCKETLEU, -UK, -US	2 x 2 pcs extra sockets for storage space		
HELP6LIGHT	Light for storage space		
DPANEL	Connection panel max. 4 connections		
DETH	RJ45 connection		
DUSB2_A_C	2xUSB chargers type A and C 1 x USB A, 1 x USB C 5V 3.0A / 9V 2.22A / 12V 1.67A		
HELP6A4FRAME	Frame for A4 training panels		

Multifunctional worktable HELP6S20

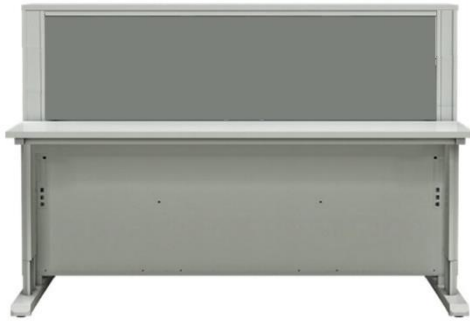

HELP6S20 storage space available

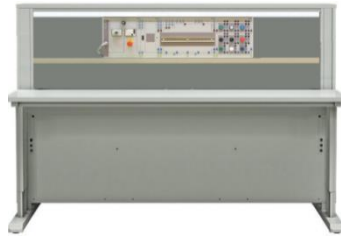

HELP6S20 storage space equipped with PC:s

HELP6S20 storage space equipped with A4 frame



HELP6S20 flat work surface

The HELP6S20 multifunctional laboratory/theory table reduces the need for cabinets and storage shelves. Saves time by avoiding unnecessary transfers of equipment. The need for space is reduced when the laboratory space can also be used as a theory class. The table has an integrated large device space that can be moved up/down, which enables, for example, the use of PC, monitors, training kits. The equipment space can be equipped with lighting, network connections, electrical outlets and shelves. The storage space can be controlled to open/close either manually from the table or with the teacher's mobile device. Applications e.g. IT, telecommunications, control mechatronics, civil engineering laboratories. The workstation is also well suited as a lockable workstation for the teacher. Together with TLMC laboratory control software, HELP6S20 workstations convert the laboratory into a multifunctional room.

- Multipurpose construction: laboratory workstation and theory desk in one solution
- Construction includes a fixed table section (2000 x 600 mm) in the front and a storage section (2000 x 525 mm) in the rear. Storage space is suitable for storing training kits, motors, soldering equipment etc. Storage space dimensions: 1800(W) x 436(D) x 500(H) mm.
- Motorized part is equipped with fast, silent and service free electric motors for moving panel up / down
- While storage section is down, devices and equipment are safe from unauthorized use
- Storage section can be driven either manually or with TMLC laboratory control software
- Safety switch between the motorized storage section and workstation frame for finger protection
- Workstation frame made of ESD painted steel
- L-shaped ergonomic legs in the front
- Table tops with laminate surface, durable rounded plastic edges, colour light speckled grey
- Load capacity for workstation: 250 kg
- Adjustment screws to eliminate the roughness of the floor
- Can be connected to LAN and used with **TLMC** software (optional)

Workstation frames, standard table top	Workstation frames, ESD table top	Table top size, W x D (mm)
HELP6S20	EHELP6S20	2000 x 1150
Options for HELP6S20 workstations		
HELP6SCM / HELP6SCB	HELP6S20control module or LAN module (needs for each storage section)	
HELP6SOCKET / -UK, -US	Integrated sockets for panel top (European schuko / UK/US type)	
HELP6FRSOCKET	2 x 2 pcs extra sockets under table top	
HELP6RACK	Rack for fume extraction system	
Options for HELP6S20 workstation		
PANSOCKETLEU, -UK, -US	2 x 2 pcs extra sockets for storage space	
HELP6LIGHT	Light for storage space	
DPANEL	Connection panel max. 4 connections	
DETH	RJ45 connection	
DUSB2_A_C	2xUSB chargers type A and C 1 x USB A, 1 x USB C 5V 3.0A / 9V 2.22A / 12V 1.67A	
HELP6SA4FRAME	Frame for A4 training panels	

BASIC WORKSTATION

More information for BASIC models, see pages 70-79

The BASIC serie uses its own device module size, see pages 73-79



BASIC workstation, low + EP15L panel



BASIC workstation, high



BASIC economical workstation + EP20L panel



BASIC workstation, Twin model



EPHELP workstation for theory lessons,
table top closed



EPHELP workstation for practical training,
table top open

ACCESSORIES



TEKLAB workstations can be equipped with versatile accessories to make the workplace more practical. Different kinds of auxiliary tops give new possibilities to combine loose instruments, tools and e.g. circuit diagrams and drawings to the workstations ergonomically. Accessories are attached to the perforated uprights of the workstation.

The standard colour of the workstations and fittings is light grey - RAL7035. However, there are many optional colours available.

DISPLAY HOLDERS

- Fixing a display to a separate holder gives more workspace on the table top
- Adjustable display holder improves work ergonomics

Models	Description
WSA93049002	Display holder
WSA890715	Display holder for perforated back panel
WSAMA3	LCD-display holder with a height adjustable arm
LCDARM	Display holder 75x75-100-100



WSA93035002



WSAMA3



WSA890715

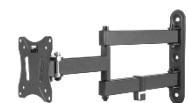

LCDARM

KEYBOARD TRAY

- Keyboard tray is fastened under the table top

Model	Size, W x D, mm	Max load, kg
WHV92549001	630 x 400	10



PC RACKS

- In TEKLAB workstations desktop computers can be placed under the table top saving workspace
- The PC racks are lockable, lock not included (except WHV861120)
- ESD powder painted steel construction
- Check the table for compatibility (X = available)



CPULUKIT,
CPULUKIT5



WHV854440



WHV860552,
WHV860740

Model	Description	Max size of PC W x D x H, mm	HELP6	HELP3	Concept	Basic	Heavy duty
CPULUKIT	PC rack, keyboard stand	230 x 430 x 430			X		X
CPULUKIT5	PC rack, keyboard stand	230 x 430 x 430	X				
CPUVTLUKITT	PC rack, extendable shelf	230 x 430 x 430	X		X		X
WHV860552	PC shelf, foot attachment	100-240 x 450 x 430		X	X		
WHV860740	PC shelf, foot attachment	100-240 x 450 x 430	X				
WHV854440	PC-holder for H-leg	180-225x450x 50				X	

DRAWER UNITS 45

- Select from two models: drawer trolley or drawer to be fixed under the table top
- Drawers equipped with ball-rails and central locking, load capacity 60 kg / drawer
- 100 % opening of the drawers
- In trolley model four swivel wheels, two with brakes, diameter 100 mm
- ESD-painted steel frame, ESD-trolley model equipped with ESD-mat and wheels
- Standard colour light grey – RAL7035, optional colours available for drawer fronts, see page 66
- Dimensions: 450(W) x 520(D) x 560(H) mm



WKL60649101



WEV60649302

Drawer to be fixed under table top	Trolley model Non ESD	Trolley model ESD	Drawers
WKL60649101	WKV60641301	WEV60649301	5 x 100 mm
WKL60649102	WKV60641302	WEV60649302	2 x 100 mm, 2 x 150 mm
WKL60649103	WKV60641303	WEV60649303	3 x 100 mm, 1 x 200 mm
WKL60649104	WKV60641304	WEV60649304	1 x 100 mm, 2 x 200 mm
WKL60649107	WKV60641307	WEV60649307	2 x 150 mm, 1 x 200 mm

DRAWER UNITS 30

- ESD-painted steel frame
- To be fixed under table top. Drawer units can also be fixed one below other
- Small drawers for tools etc.
- Drawers equipped with a lock
- Drawer opening 80%
- Internal drawer dimensions: 253(W) x 429(D) x 130(H) mm

Model	Size, W x D x H, mm	Max load, kg
WKS859330	300 x 454 x 150, 1 drawer	10
WKS859340	300 x 454 x 222, 2 drawers	20
WKS860972	350 x 450 x 470, cabinet	25
WKS860918	350 x 450 x 555, cabinet, wheels	25



WKS859330



WKS860918

UPRIGHT TUBES

- Perforated upright tubes for fastening accessories to workstations
- Made of ESD painted steel, 30(W) x 60(D) mm
- Removable

Model	Height
WPE860024	1359 mm
WPE860367	996 mm
WPE860142	800 mm



SHELVES

- Structure made of ESD painted steel

Model	Size, W x D, mm	Max load kg
WHT860804	490 x 300	50
WHT860805	490 x 400	50
WHT836028	740 x 300	50
WHT852770	740 x 400	50
WHT852283	890 x 300	50
WHT852796	890 x 400	50
WHT890631	990 x 300	50
WHT891632	990 x 400	50
WTL820471	600 x 200, fixed to perforated back panel	7



PERFORATED BACK PANELS

- Structure made of ESD painted steel
- Can be used to attach accessories such as hooks or suspension rails
- Standard colour, RAL7035, optional colours available

Model	Dimensions (W) x (H)
WPT861501	468 x 389 mm
WPT861511	718 x 389 mm
WPT861516	871 x 389 mm
WTL861532	968 x 389 mm



SUSPENSION RAILS AND PICK-UP BOXES

- Structure made of ESD painted steel

Model	Description	Max load
WHL859150	Suspension rail, 492(W) x 100(H) mm	50 kg
WHL859151	Suspension rail, 742 (W) x 100(H) mm	50 kg
WHL859152	Suspension rail, 895(W) x 100(H) mm	50 kg
WHL859156	Suspension rail, 967(W) x 100(H) mm	50 kg
WEL806207	Pick-up box, 105(W) x 165(D) x 75(H) mm	2 kg



TRAINING PANEL FRAMES AND -BOX

- Frame for A4 training panels
- Easily fastening and removing of panels

Model	Description
A4FRAME12(D)	Training panel frame, width 1200 mm, one row
A4FRAME15(D)	Training panel frame, width 1500 mm, one row
A4FRAME18(D)	Training panel frame, width 1800 mm, one row
A4 A5FRAME720	Assembly plate for A5 training panels
* D model includes two rows	
TABOX	Assembly box for A5 training panels, 840 mm



LIGHT / BALANCER RAILS

- Rail can be used to attach light ergonomically above the workstation
- Structure made of ESD-painted steel
- Height and depth adjustment

Model	Description
WSK91849006	Light / balancer rail, width 1500 mm
WSK91849008	Light / balancer rail, width 1800 mm
WSK91849003	Light / balancer rail, width 2000 mm



LIGHT

- LED light
- Colour rendering index: CRI > Ra 80
- Colour temperature: 4000 K
- Colour consistency max 3 SDCM
- Lifetime > 50 000 hours (L90B10)
- One touch dim button switch for ON/OFF and dimming in the luminaire body
- Dimmable 10-100 % (WSKTIL850 not incl. dimming)
- Includes 5 pcs plastic clips for attaching cables to bench uprights
- Dimensions
 - LTNL1200: 1180mm x 120mm x 50mm
 - LTNL500W: 430 mm x 120 mm x 50 mm
 - WSKTIL850 850 mm x 67 mm x 80 mm



LTNL1200, WSKTIL850



LTNL500W

Model	Fixing type	Luminous flux	Illuminance	Luminous efficacy	Power	Adjustability
WSKTIL850	Light rail	3800 lm	3100 lx ±10 % (@ 1m)	125 lm/W	56 W	±45° vertically
LTNL1200	Light rail	7100 lm	3100 lx ±10 % (@ 1m)	125 lm/W	56 W	±45° vertically
LTNL500W	Upright tube	1750 lm	800 lx ±10 % (@ 1m)	110 lm/W	14 W	±45° vertically, ±90° horizontally

CABLE DUCTS

- Cable ducts hide untidy cables and keep the back side of the workstation tidy
- Structure made of ESD painted steel



Model	Description
WPK860808	Cable duct M500, 467x360 mm
WPK860044	Cable duct M750, 717x360 mm
WPK860045	Cable duct M900, 870x360 mm

DOCUMENT HOLDER

- Documents and drawings can be easily placed on the document holder with two magnets included
- Structure made of ESD painted steel



Model	Size, W x D, mm	Max load, kg
WSI92849008	290 x 330	5

TOOL PANEL

- Perforated tool panel, includes 6 pcs hooks
- Structure made of ESD painted steel



Model	Size, W x D, mm	Max load, kg
WST92849010	267 x 305	5

AUXILIARY TOP

- Can be rotated 360°, tilt adjustment 0-25°
- Structure made of ESD painted steel



Models	Size, W x D, mm	Max load, kg
WSA92749001	560 x 340	15
WSA92749002	605 x 405	15

HOOK SETS

- Hook sets can be fastened to perforated plates

Models	Description
WHR855001	Series 1, 20 pcs hooks
WHR855003	Series 3, 69 pcs hooks



FOOT REST

- Freestanding model
- Tilt adjustment 5-30 °

Model	Dimensions
WTT860947	550 x 350 mm



INSTRUMENT SUPPORT

- Support for different types of process instruments (pressure transmitters, switches etc.)
- Properly fastened instrument makes calibration and repair work easier
- Includes a plate and a tube bracket to be compatible with standard size devices

Model	Size, W x D x H, mm
INSTRSU	240 x 260 x 318



WHEELS FOR WORKSTATIONS

- Diameter of wheels 100 mm, two wheels with brakes

Model	Description
WPP834734	Standard
WEP860429	ESD
1987	Swivel castors (TABHEAVYxxx)
1988	Fixed castors (TABHEAVYxxx)



TRANSPORT SKATES FOR WORKSTATIONS

- With transport skates, one person can easily move the workstation

Model	Description
TRSK	1 pair transport skates

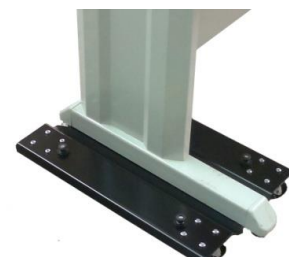

CABINETS

- Cabinets bring tidiness, order and efficiency to the work environment
- Cabinets are made of ESD-painted steel
- Available are practical accessories such as extendable shelves and drawers with ball-race rails, steel shelves, perforated plates for doors and side walls etc.

Model	Description	Dimensions, W x D x H, mm
TKCABIN1	Tool cabinet, two shelves, perforated panels, hook series 60 pcs	1024 x 500 x 2000
TKSARJA5	Tool set to be attached to TKCABIN1 cabinet, 60 tools	
TKCABIN2	General purpose cabinet, two shelves	800 x 400 x 1000
TKCABIN4	Training kit cabinet, acrylic glass doors, four shelves	1024 x 400 x 2000
TKCABIN5	Training kit cabinet, acrylic glass doors, four shelves	1024 x 500 x 2000
WVK821465	Perforated tool cabinet	720 x 255 x 300
WVK820800	Perforated tool cabinet	720 x 255 x 400
WRL836273	Shelf for the perforated cabinet	715 x 175 x 15
TKBT550BESD	Small part cabinet	790 x 760 x 1770



TKCABIN1 + TKSARJA5



TKCABIN2



TKBT550BESD



TKCABIN4, TKCABIN5



WVK821465, WVK820800

CHAIRS

Standard models



Standard models	Description
C15PU	Stool, black, polyurethane, height adjustment, castors with load-sensitive brakes.
C20PU	Chair, black, polyurethane, height/backrest/tilt adjustment, castors with load-sensitive brakes
C25PU	Chair, black, polyurethane, height/backrest/tilt adjustment, castors with load-sensitive brakes, high version, foot ring, glides
C40BL	Chair, black, fabric, height/backrest/tilt/depth adjustment, castors with load-sensitive brakes
SADDLEL	Saddle chair, black, leather, height/tilt adjustment, castors with load-sensitive brakes.

ESD models



ESD models	Description
C20PU-ESD	ESD chair, black, polyurethane, height/backrest/tilt adjustment, castors with load-sensitive brakes
C25PU-ESD	ESD chair, black, polyurethane, height/backrest/tilt adjustment, castors with load-sensitive brakes, high version, foot ring, glides
C40BL-ESD	ESD chair, black, fabric, height/backrest/tilt/depth adjustment, castors with load-sensitive brakes

Options

Options	Description
ARE	3D armrests for Cxxxx chairs, adjustment of height and width with possibility to swivel
ARE-ESD	4D ESD armrests for Cxxxx-ESD chairs, adjustment of height, width and depth with possibility to swivel.
CRING	Chrome-plated foot ring. Foot ring can also be retrofitted to our lower chair models by attaching it to the chair column. Can be used on both ESD and non-ESD models. The height can be easily adjusted without any tools.

SAP TROLLEY

- All wheels, diameter 100 mm, with swivel, two with brakes
- Includes a lower surface
- Height adjustable between 650 - 900 mm
- Loading capacity: 150 kg
- Can be equipped with a PUSH-handle

Model	Dimensions, W x D x H, mm
WESSAP507	700 x 500 x 650-900
WESSAP507ESD	700 x 500 x 650-900, ESD
PUSH50	Handle for trolley



CONCEPT TROLLEY

- All wheels, diameter 100 mm, with swivel, two with brakes
- ESD-protected
- Height adjustable between 650 - 900 mm
- An integrated bottom shelf, powder coated (RAL 7035) steel, max load 25 kg
- Can be equipped with an additional shelf or drawer unit WKS859330 or WKS859340
- Total max. load: 150 kg



Model	Description	Dimensions, W x D x H, mm
WESCONT705	Concept-trolley, ESD	750 x 500 x 650-900
WESCONTS504	Extra shelf for Concept-trolley ESD	500 x 400

MULTI TROLLEYS

- An ergonomic mobile workstation
- Can be equipped with additional tops, shelves etc.
- ESD-protected
- Four swivel wheels, two with brakes
- Max load: 300 kg
- Ask for a separate catalogue for more information

Model	Description	Size, W x D x H, mm
TMTL5-001-49	Multi trolley 1, 2 shelves	540 x 760 x 1130
TMTL7-001-49	Multi trolley 1, 2 shelves	790 x 760 x 1130
TMTL9-001-49	Multi trolley 1, 2 shelves	943 x 760 x 1130
TMTH5-001-49	Multi trolley 2, 4 shelves	540 x 760 x 1790
TMTH7-001-49	Multi trolley 2, 4 shelves	790 x 760 x 1790
TMTH9-001-49	Multi trolley 2, 4 shelves	943 x 760 x 1790



Multitrolley 1

Multitrolley 2

SU1

1 phase supply unit

- Main switch for the workstation with START-position
- Green indicator light
- Integrated emergency switch, reset from the main switch
- Automatic restart prevention system e.g. after power failure
- 16 A thermal overload protector
- Fault current protection (RCD, A-type) 0.03 A for all devices connected to the supply unit
- Earth terminal screw
- Outlets for the device modules
- Dimensions: ½-module, 125(W) x 200(H) mm
- Options:
 - **SULOCK** Electricity locking module
 - **SULOCK1** Power and equipment control module
 - **RCDB** B-types RCD



SU3

3 phase supply unit

- Main switch for the workstation with START-position
- Green indicators
- Integrated emergency switch, reset from the operating switch
- Automatic restart prevention system e.g. after power failure
- Protection circuit for missing phase / wrong phase order
- 16A thermal overload protector for each phase
- Fault current protection (RCD, A-type) 0.03 A for all devices connected to the supply unit
- Earth terminal screw
- Connector for 3-phase (3L+N+PE) device module
- Outlets for the device modules
- Dimensions: ½-module, 125(W) x 200(H) mm
- Options: **SULOCK** Electricity locking module **SULOCK1** Power and equipment control module



SU332

3 phase supply unit

- Main switch for the workstation
- Green indicator light
- Emergency switch
- Automatic restart prevention system e.g. after power failure
- Protection circuit for missing phase/wrong phase order
- 32 A and 16 A circuit breakers
- Fault current protection (RCD, A-type) 0.03 A for all devices
- 3-phase 32 A socket at the front panel
- Earth terminal screw
- Outlets for the device modules in the workstation
- Dimensions: 1 ½-module, 375(W) x 200(H) mm
- Option: **SULOCK** Electricity locking module



Supply units

SU363

3 phase supply unit

- Main switch for the workstation
- Green indicator light
- Emergency switch
- Automatic restart prevention system e.g. after power failure
- Protection circuit for missing phase/wrong phase order
- 63 A and 16 A circuit breakers
- 3-phase 63 A socket at the front panel
- Outlets for the device modules in the workstation
- Dimensions: 1 ½-module, 375(W) x 200(H) mm
- Option: **SULOCK** Electricity locking module

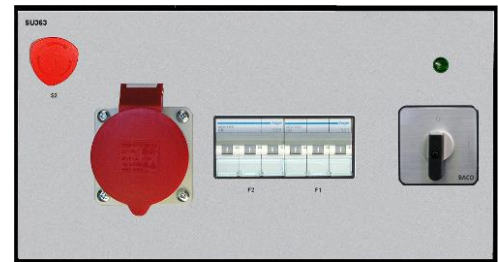

SUNET

Supply unit control module

- Enables remote control for electricity in the workbench (requires TLMC software)
- Features
 - Connection permission for power
 - Power off control
 - Power on/off status information
- Key switch for bypassing software control
- Ethernet connection
- Dimensions: ¼ module, 62.5(W) x 200(H) mm



SULOCK

Electricity locking module

- Electricity locking with key
- Dimensions: ¼ module, 62.5(W) x 200(H) mm

SULOCK1

Power and equipment control module

- With key switch can be prevented power and pre-selected equipment switching on
- Position 0; power off
- Position 1; power on, but pre-selected equipment are locked
- Position 2; power and all equipment are allowed
- Dimensions: ¼ module, 62.5(W) x 200(H) mm



DCA305PS

Variable DC power supply

- Output values: 0-30 V, 0-5 A
- Short-circuit protected
- Stepless adjustment for output voltage with fine tuning
- Stepless adjustment for current limitation with fine tuning
- Measurement of current and voltage with digital meters
- Output from 4 mm safety terminals
- Dimensions: ½-module, 125(W) x 200(H) mm



DCAEL303R

Variable DC power supply

- Output values: 0-30 V, 0-3 A, 90 W
- Linear regulation
- Constant voltage or constant current operation
- Voltage Setting: By coarse and fine controls
- Current Setting: By single logarithmic control
- Independent digital voltage and current meters for each output with 4 digit resolution
- Voltage meter:
 - Resolution: 10 mV
 - Accuracy: 0.3 % of reading \pm 3 digits
- Current Meter:
 - Resolution: 1 mA
 - Accuracy: 0.5 % of reading \pm 3 digits
- Ripple & noise: Typically < 1 mV rms (CV mode, 20 mHz bandwidth)
- Switchable local or remote sensing
- Silent fan-free cooling
- DC output on/off switch
- All outputs are intrinsically short circuit proof, and are protected against external voltages and reverse currents
- Output terminals: Universal 4mm safety binding posts on 19mm (0.75") spacing. Terminals can accept fixed shroud 4 mm plugs, standard 4 mm plugs, fork terminals and bare wires
- Dimensions: ¾ module, 187,5(W) x 200(H) mm
- Option: **TTICAL** Calibration certificate with results



DCAEL302RD

Variable DC power supply

- Output values: 2 x 0-30 V, 0-2 A, total power 2x60 W
- The two outputs are independent and isolated
- The outputs can be wired in either series or parallel to provide voltages up to 60 volts or currents up to 4 amps
- Linear regulation
- Constant voltage or constant current operation
- Voltage Setting: By coarse and fine controls
- Current Setting: By single logarithmic control
- Independent digital voltage and current meters for each output with 4 digit resolution
- Voltage meter:
 - Resolution: 10 mV
 - Accuracy: 0.3 % of reading ± 3 digits
- Current Meter:
 - Resolution: 1 mA
 - Accuracy: 0.5 % of reading ± 3 digits
- Ripple & noise: Typically < 1 mV rms (CV mode, 20 MHz bandwidth)
- Switchable local or remote sensing
- Silent fan-free cooling
- DC output on/off switch
- All outputs are intrinsically short circuit proof, and are protected against external voltages and reverse currents
- Output terminals: Universal 4mm safety binding posts on 19mm (0.75") spacing. Terminals can accept fixed shroud 4 mm plugs, standard 4 mm plugs, fork terminals and bare wires
- Dimensions: 1 ¼ module, 312,5(W) x 200(H) mm
- Option: **TTICAL** Calibration certificate with results



DCAEX355R, DCAEX354RD

Variable DC power supply

- Output values:
 - **DCAEX355R** 0-35 V, 0-5 A, 175 W
 - **DCAEX354RD** 2 x 0-35 V, 0-4 A, 2x140 W
- Mixed-mode regulation
- Constant voltage or constant current operation
- Voltage Setting: By coarse and fine controls
- Current Setting: By single logarithmic control
- Independent digital voltage and current meters for each output with 4 digit resolution
 - Voltage meter: Resolution: 10 mV
 - Accuracy: 0.3 % of reading ± 3 digits
- Current Meter: Resolution: 1 mA
 - Accuracy: 0.5 % of reading ± 3 digits
- Ripple & noise: Typically < 1 mV rms (CV mode, 20 MHz bandwidth)
- Switchable local or remote sensing
- Silent fan-free cooling
- DC output on/off switch
- All outputs are intrinsically short circuit proof, and are protected against external voltages and reverse currents
- Output terminals: Universal 4mm safety binding posts on 19 mm (0.75") spacing. Terminals can accept fixed shroud 4 mm plugs, standard 4 mm plugs, fork terminals and bare wires
- Dimensions: ¾ module, 187,5(W) x 200(H) mm (DCAEX355R)
1 ¼ module 312.5(W) x 200(H) mm (DCAEX354RD)
- Option: **TTICAL** Calibration certificate with results



DCAEX355R



DCAEX354RD

DCACPX400S, DCACPX400SP, DCACPX400D

Variable DC power supply

- Output values: 0-60 V, 0-20 A, 420 W (DCACPX400S)
- Output values: 2 x 0-60 V, 0-20 A, 2 x 420 W (DCACPX400D)
- PowerFlex design gives variable voltage and current combinations within a maximum power range
- PowerFlex or fixed-range operation plus custom limits
- Constant voltage or constant current operation
- Independent outputs or isolated voltage tracking (DCACPX400D)
- Outputs can be wired in series or parallel for 120 V or 40 A
- Variable OVP trips
- True analogue controls
- Voltage Setting: By coarse and fine controls
- Current Setting: By single logarithmic control
- Settings locking
- Independent digital voltage and current meters for each output with 4 digit resolution
- Voltage meter: Resolution: 10 mV
 - Accuracy: 0.1 % of reading \pm 2 digits
- Current Meter: Resolution: 10 mA
 - Accuracy: 0.3 % of reading \pm 20 mA
- Ripple & noise: Typically < 3 mV rms (CV mode)
- Switchable local or remote sensing
- LED indication of Output On, V/I Limits, CV, CI, Power Limit
- Silent fan-free cooling
- DC output on/off switch
- All outputs are intrinsically short circuit proof
- Output terminals can accept fixed shroud 4 mm plugs, standard 4 mm plugs, fork terminals and bare wires
- Dimensions: ½ module, 125(W) x 200(H) mm (DCACPX400S)
- Dimensions: 1 module, 250(W) x 200(H) mm (DCACPX400D)
- Options:
 - **TTICAL** Calibration certificate with results
 - **DCAETHERNET** Ethernet connection and control program (DCACPX400SP)



DCACPX400S



DCACPX400D

DCA25004, DCA25009, DCA25013

Variable DC power supply

- Output: 0-250 V DC, 0-4.5 A, max. 360 W (DCA25004)
- Output: 0-250 V DC, 0-9 A, max. 720 W (DCA25009)
- Output: 0-250 V DC, 0-13.5 A, max. 1080 W (DCA25013)
- Ripple and noise: 80 mV p-p (DCA25004), 120 mV p-p (DCA25013),
- Programmable functions
- Output from 4 mm safety terminals
- Dimensions: ½ module 125(W) x 200(H) mm (DCA25004), 1 module 250(W) x 200(H) mm (DCA25009), 1 ¼ module 312.5(W) x 200(H) mm (DCA25013),



DCA25013

DCAMX100T

Variable DC power supply

- 3 ranges:
 - Range 1: 3 x 0-35 V, 0-3 A, max. 315 W
 - Range 2: 2 x 0-16 V, 6 A and 70 V, 1,5 A, max. 315 W
 - Range 3: 0-35 V, 6 A or 0-70 V, 3 A, max. 210 W
- Constant voltage or constant current operation
- Variable OVP and OCP trips on all outputs
- Range switching gives variable voltage/current combinations
- Shared power mode provides double power from a single output
- Low output noise and ripple via linear final regulation
- High setting resolution of up to 1mV and 0.1 mA
- 50 setting memories per output plus 50 linked memories
- Selectable voltage tracking (isolated tracking)
- Selectable current meter averaging
- Switchable remote sense capability
- Graphic LCD provides simultaneous output metering
- Numeric or spin-wheel control of all parameters
- Individual or combined output on/off control with programmable delay sequencing.
- Dimensions: 1 module, 250(W) x 200(H) mm
 - Option:
 - TTICAL Calibration certificate with results



ELLOAD

Programmable Electronic DC load

- 0-120 V, 0-30 A, 150 W
- Dynamic mode: up to 10 kHz
- Resolution of voltage and current: 0.1 mV/0.1 mA
- 4 working modes: CV/CC/CR/CW
- Remote sensing function
- Battery test, automatic test, OPP test, OCP test functions
- 100 sets of storage
- Short circuit function
- Current monitoring function
- Power off memory function
- Interfaces: USB, RS232 & LAN
- Dimensions: Full module, 250(W) x 200(H) mm



TLMB12

Fixed DC power supply

- Linear power supply
- 4 outputs, floating with respect to each other
- Outputs can be connected in series or in parallel
- Output values:
 - Output 1: 1.5 V / 3 V / 4.5 V / 5 V / 6 V / 9 V, 1 A
 - Output 2: 5 V / 3.3 V, 3 A
 - Output 3: 12 V / 15 V, 1 A
 - Output 4: 12 V / 15 V, 1 A
- Current limitation indicated by a LED
- Ripple: < 10 mV_{PP}
- All outputs are short-circuit protected
- Voltage accuracy better than 100 mV
- Output from 4 mm safety terminals
- Dimensions: ½-module, 125(W) x 200(H) mm



DCF series

Fixed DC power supply

- Output values:
 - DCF1212: 12 V, 12 A DC
 - DCF242: 2 x 24 V, 2 A DC
 - DCF242R: 24 V, 2 A DC, 250 ohm series resistor
 - DCF246: 24 V, 6 A DC
 - DCF3355: 3,3V / 5A+ 5V / 5A DC
 - DCF532: 2x5V/3A DC
- Ripple:
 - DCF1212: < 100 mV_{PP}
 - DCF242: < 50 mV_{PP}
 - DCF242R: < 50 mV_{PP}
 - DCF246: < 50 mV_{PP}
 - DCF3355: < 50 mV_{PP}
 - DCF532: < 50 mV_{PP}
- Output floating, can be connected in series or in parallel
- Overcurrent limiter, indicated by a LED
- Outputs from 4 mm safety terminals
- Dimensions: ¼-module, 62.5(W) x 200(H) mm



ACA505

1 phase variable AC power supply

- Variable transformer 0-50 V, 5 A AC, 230 VA
- Galvanic isolation
- Overload protection
- Output: 4 mm safety terminals
- Digital meters for output voltage and current
- Voltage measuring: 0-10 V AC, best resolution 1 mV and 10-50 VAC 10 mV, accuracy 1 %
- Current measuring: 0-5 A AC, best resolution 10 mA, accuracy 1 %
- Main switch with indicator light
- Dimensions: 1 module, 250(W) x 200(H) mm
- Options:
 - **TEKLBCAL** Calibration for a TEKLAB device



ACA25010

1 phase variable AC power supply

- Variable transformer 0-250 V, 10 A, max. 2200 VA
- Galvanic isolation
- Two outputs (one active at a time)
- Output 1: socket, unearthed
- Output 2: 4 mm safety terminals
- Dedicated output ON/OFF buttons, indicator lights
- Graphical OLED display
- Voltage measurement:
 - Resolution: 1 V
 - Accuracy: ± 1.5 V
- Current measurement:
 - Resolution: 0.1 A
 - Accuracy: ± 0.15 A
- Max-min display
- Overvoltage and overcurrent protection, user settable, based on measurements
- Electronic and electro-mechanical overload protection
- Main switch with indicator light
- Start-up current peak limiter
- Dimensions: 1 ½ module, 375(W) x 200(H) mm
- Options:
 - **ACASOCKUK** UK-socket (BS1363) for ACA power supply
 - **ACASOCKUS** US-socket (NEMA 6-20R) for ACA power supply
 - **TEKLBCAL** Calibration for a TEKLAB device



ACP40

1 phase programmable AC power supply

- Output values: 0 - 250 V, 0 - 4 A, 900 VA
- Galvanic isolation
- Digital display for viewing output voltage, current and settings
- Setting accuracy and display resolution: 1 V / 0.1 A
- Measuring accuracy: Voltage: ± 2 V, Current: ± 0.1 A
- Overvoltage protection setting 0 - 250 V, overcurrent protection setting 0 - 4 A with OFF-position
- Short-circuit protection
- Outputs from 4 mm safety terminals or from unearthed socket (one output active at a time)
- Output ON/OFF-buttons with indicator lights
- Automatic self-test and line voltage measurement when starting
- Stability feature for stabilizing output voltage
- Firmware update possibility
- Options: Ethernet connection **ACPETHERNET**
 - Control program
 - Fast two-way communication
 - Versatile user interface enables e.g. automatic measurements without programming
 - Advanced datalogging function enables e.g. simultaneous follow-up and saving of several quantities, or saving of an individual value by the snapshot function
- LabView-driver
 - Advanced TCP/IP based LabVIEW driver speeds up making own applications
- Dimensions: ½-module, 125(W) x 200(H) mm
- Options:
 - **ACPSOCKETUK** UK-socket for ACP power supply
 - **ACPSOCKETUS** US-socket for ACP power supply



TEKLAB <--> NET



ACP100

1 phase programmable AC power supply

- Output values: 0 - 250 V, 0 - 10 A, 2000 VA
- Galvanic isolation
- Digital display for viewing output voltage, current and settings
- Setting accuracy and display resolution: 1 V / 0.1 A
- Measuring accuracy: Voltage: ± 2 V, Current: ± 0.1 A
- Overvoltage protection setting 0 - 250 V, overcurrent protection setting 0 - 10 A with OFF-position
- Short-circuit protected
- Outputs from 4 mm safety terminals or from unearthed socket (one output active at a time)
- Output ON/OFF-buttons with indicator lights
- Automatic self-test and line voltage measurement when starting
- Stability feature for stabilizing output voltage
- Firmware update possibility
- Dimensions: Full-module, 250(W) x 200(H) mm
- Options: Ethernet connection **ACPETHERNET**
 - Control program
 - Fast two-way communication
 - Versatile user interface enables e.g. automatic measurements without programming
 - Advanced datalogging function enables e.g. simultaneous follow-up and saving of several quantities, or saving of an individual value by the snapshot function
- LabView-driver
 - Advanced TCP/IP based LabVIEW driver speeds up making own applications
- Options:
 - **ACPSOCKETUK** UK-socket for ACP power supply
 - **ACPSOCKETUS** US-socket for ACP power supply



TEKLAB <--> NET



ACA5053, ACA50163**3 phase variable AC power supply**

- Galvanic isolation
- Output value: 0-50 V, 5 A (4 mm safety terminals)
- Output value: 0-50 V, 16 A (4 mm safety terminals)
- Analog voltage measurement (L1-N)
- Thermal / magnetic circuit breaker
- Dimensions: 1 ¼ -module, 312.5(W) x 200(H) mm

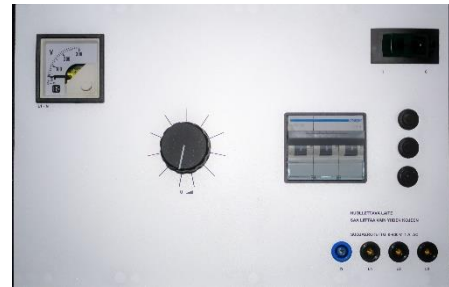
**ACA4002****3 phase variable AC power supply**

- Galvanic isolation
 - Output: 0-400 V, 2 A (4 mm safety terminals)
- Analog voltage measurement (L1-N)
- Thermal / magnetic circuit breaker
- Dimensions: 1 ¼ -module, 312.5(W) x 200(H) mm
- Options
 - **ACM3VVA** analogue voltage meters 0 - 400 V
 - **ACM3V20AA** 3 pcs analog ammeters 0-2 A
 - **PM3AB** Power analyzer for 1- and 3-phase using less than 5 A current (see page 48)

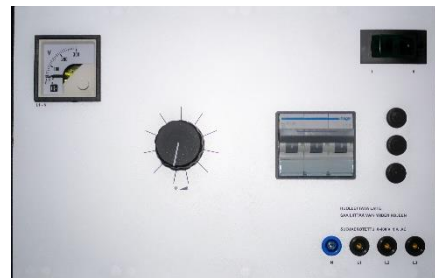
**ACA40016****3 phase variable AC power supply**

- A push-button to control variable transformer
- Galvanic isolation
- Output values:
 - Output 1: 0-400 V, 16 A (unearthed socket)
 - Output 2: 0-400 V, 16 A (4 mm safety terminals)
- Output selection switch, one output active at a time
- Analog voltage measurement (L1-N)
- Thermal / magnetic circuit breaker
- Transformers are placed in separate floor-standing housing
- Dimensions: Full-module, 250(W) x 200(H) mm
- Options:
 - **ACM3VVA** analogue voltage meters 0 - 400 V
 - **ACM3V160AA** analogue current meters 0 - 16 A
 - **PM3A** Power analyzer for 3-phase up to 25 A current (see page 48)



3 phase AC power supplies

ACA6904M, ACA6909

3 phase variable AC power supply

- A push-button to control variable transformer
- Galvanic isolation
- Output values:
 - Output 1 ACA6904M: 0-690 V, 4 A (unearthed socket)
 - Output 2 ACA6904M: 0-690 V, 4 A (4 mm safety terminals)
 - Output 1 ACA6909: 0-690 V, 9 A (unearthed socket)
 - Output 2 ACA6909: 0-690 V, 9 A (4 mm safety terminals)
- Output selection switch, one output active at a time
- Analog voltage measurement L1-N) +L1-L2, L2 -L3, L1 and L3
- Analog current measurement L1, L2 and L3
- Thermal / magnetic circuit breaker
- Dimensions: 1 ½ -module, 375(W) x 200(H) mm
- Options
 - **PM3AB** Power analyzer for 1- and 3-phase using less than 5 A current (see page 48)



MT63

3 phase power supply for motor testing

- Test unit for electric motors based on AC-drive technology
- For electric motors with operating voltage range of 380-480 V AC
- Output current max. 63 A
- Control / measurement unit
- Measurements with 3 parameters on display at a time: voltage, current, speed, power, run time, output frequency, Kwh counter, reserve
- Output ON/OFF buttons
- 4 programmable buttons for test ramps
- Software for loading motor parameters
- Output connectors for motor test cables 16 A and 63 A
- Requires SU363 supply unit
- Dimensions: 1 ½ -module, 375(W) x 200(H) mm
- Standard accessories
 - Motor test cable 16 A, 3 m
 - Motor test cable 63 A, 3 m
 - Alarm light unit

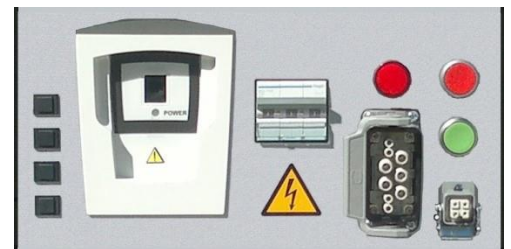

RB3

Rectifier

- 3-phase diode rectifier bridge, no filtration
- Can be used also as 1-phase rectifier
- Maximum input voltage 700 V AC
- Maximum output current: 20 A
- Dimensions: ¼-module, 62.5(W) x 200(H) mm



ACM3VVA, ACM3V20AA, ACM3V160AA

Measuring accessory

- Measuring accessory for 3 phase AC power supplies
- 3 pcs analog voltmeters, 0-400 V, L1-L2, L2-L3 and L3-L1 (ACM3VVA)
- 3 pcs analog ammeters 0-2 A, L1, L2 and L3 (ACM3V20AA)
- 3 pcs analog ammeters 0-16 A, L1, L2 and L3 (ACM3V160AA)
- Accuracy. $\pm 1.5\%$
- Dimensions: $\frac{1}{4}$ -module, 62.5(W) x 200(H) mm

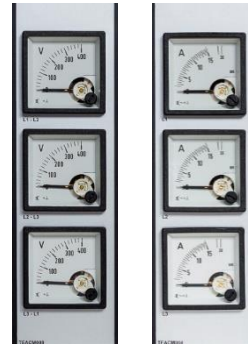

ACF2304, ACF23010

Isolated 1 phase AC connection

- Galvanically isolated AC outlet
- Output values:
 - ACF2304: 230 V, 4 A, max. 1000 VA
 - ACF23010: 230 V, 10 A, max. 2000 VA
- Overload protectors for primary / secondary circuits
- Electronic attenuator for restricting switching current
- Dimensions:
 - ACF2304: ½-module, 125(W) x 200(H) mm
 - ACF23010: ¾-module, 187.5(W) x 200(H) mm
- Options:
 - **ACFSOCKETUK** UK socket for AC outlet
 - **ACFSOCKETUS** US-socket for AC outlet
 - **PM3AB** Power analyzer for 1- and 3-phase using less than 5 A current (ACF2304) (see page 48)
 - **PM3A1** Power analyzer for 1-phase up to 25 A current (ACF23010) (see page 48)



ACF1154

Isolated 1 phase AC connection

- Galvanically isolated AC outlet
- Output: 115 V, 4 A, max. 500 VA
- Overload protectors for primary / secondary circuits
- Electronic attenuator for restricting switching current
- Dimensions: ½-module, 125(W) x 200(H) mm



ACF23010M

AC outlet with isolation level monitoring

- AC outlet equipped with isolation level monitoring system
- Suitable to be used in medical equipment maintenance workshops
- Provides constant, safe and secure monitoring of electrical systems with IT type grounding
- Very early detection of potential insulation deteriorations, PE-wires and isolation transformer malfunctions
- Includes a transformer (2300 VA) to enable isolation level measurements
- Output from earthed schuko socket: 230 V: 2300 VA
- Overload protection
- Dimensions: 1 ¾ module, 375(W) x 200(H) mm



3 phase AC connections

ACF40016G

3-phase AC connection

- Two safety earthed AC outputs:
 - Output 1: Socket, 230 / 400 V AC, 16 A, 3L+N+PE
 - Output 2: 4 mm safety terminals, 230 / 400 V AC, 16 A, 3L+N+PE
- Main switch / output selection switch, one output active at a time
- Analog ammeters 0-16 A for L1, L2, L3
- Thermal / magnetic circuit breaker, 16 A
- Dimensions: 1 module, 250(W) x 200(H) mm
- Options:
 - **PM3A** Power analyzer for 3-phase up to 25 A current (see page 48)



ACF4002

Isolated 3-phase AC connection

- Two 3-phase AC outputs with galvanic isolation:
 - Output 1: Socket, 230 / 400 V AC, 2 A, 3L+N
 - Output 2: 4 mm safety terminals, 230 / 400 V AC, 2 A, 3L+N
- Main switch / output selection switch, one output active at a time
- 3 pcs 500 VA ring core isolation transformers
- Analog ammeters 0-2 A for L1, L2, L3
- Thermal / magnetic circuit breaker, 2 A
- Dimensions: 1 ½ module, 375(W) x 200(H) mm
- Options:
 - **PM3AB** Power analyzer for 1- and 3-phase using less than 5 A current (see page 48)



ACF40016

Isolated 3-phase AC connection

- Two 3-phase AC outputs with galvanic isolation:
 - Output 1: Socket, 230 / 400 V AC, 16 A, 3L+N
 - Output 2: 4 mm safety terminals, 230 / 400 V AC, 16 A, 3L+N
- Main switch / output selection switch, one output active at a time
- 3 pcs 3700 VA ring core isolation transformers
- Analog ammeters 0-16 A for L1, L2, L3
- Thermal / magnetic circuit breaker, 16 A
- Includes a separate floor-standing casing for isolation transformers
- Dimensions: 1 module, 250(W) x 200(H) mm
- Options:
 - **PM3A** Power analyzer for 3-phase up to 25 A current (see page 48)



ELPSLxx

1 phase socket outlets

- Standard models:
 - **ELPSL2** 2 x schuko sockets
 - **ELPSL1USB_A,C** 1 x schuko socket +1 x USB A, 1 x USB C
5V 3.0A / 9V 2.22A / 12V 1.67A
 - **ELPSL2GB** 2 x UK-sockets
 - **ELPSL1GBUSB_A,C** 1 x UK-socket +1 x USB A, 1 x USB C
5V 3.0A / 9V 2.22A / 12V 1.67A
 - **ELPSL2US** 2 x US-sockets
 - **ELPS1USUSB_A,C** 1 x US-socket +1 x USB A, 1 x USB C
5V 3.0A / 9V 2.22A / 12V 1.67A
 - **ELPSL2US** 2 x US-sockets
 - **ELPSL2S** 2 x CEE sockets, 1-phase
- Other socket models also available
- Dimensions: ¼-module, 62.5(W) x 200(H) mm
- Dimensions: ½ -module, 125(W) x 200(H) mm (ELPSL2S)



ELPSL3V

3 phase socket outlet

- 3 phase extra socket
- 5-pole 16 A CEE socket
- Dimensions: ½-module, 125(W) x 200(H) mm



D-CONNECTIONS

USB and Ethernet connections

- **DPANEL** Connection panel max. 4 connections
- **DETH** RJ45 connection
- **DUSB2_A,C** 1 x USB A, 1 x USB C 5V 3.0A / 9V 2.22A / 12V 1.67A
- Dimensions: ¼-module, 62.5(W) x 200(H) mm
- **USB1T**
 - Single USB-connection between a PC and a panel device
 - Type B connector at the back of the device panel



STO40016

Safety terminal outlets

- AC outlets from 4 mm safety terminals
- 3L+N+PE, 400 V, 16 A
- Dimensions: ¼-module, 62.5(W) x 200(H) mm



PILT

Compressed air connection

- 2 pcs ½" snap-on connectors
- Dimensions: ¼-module, 62.5(W) x 200(H) mm



S40US, S100US

Power transformer

- Transformer to power instrument modules in workstations that are connected to 115 V electrical network
- S40US: 115 V / 230 V, 1000 VA, S100US: 115 V / 230 V, 2000 VA
- Dimensions:
 - S40US: ½-module, 125(W) x 200(H) mm
 - S100US: ¾-module, 187.5(W) x 200(H) mm

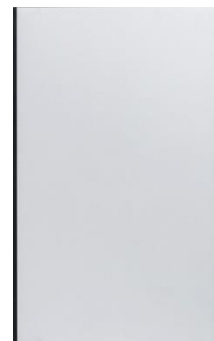

LAN8

Ethernet switch

- 8-port 1 G Ethernet switch
- 1 x RJ45 at the front panel for an optional device
- 1 x RJ45 at the table frame for laboratory network connection
- 6 x RJ45 for instrument modules
- Dimensions, ¼ module, 62.5(W) x 200(H) mm



LANWBRIDGE

Wireless LAN bridge

- A wireless link between a workstation and laboratory Wireless Access Point
- Available also for a single device control
- Antenna mounted in the workstation
- 802.11 a/b/g/n/ac standard

STRBOX

Storage module

- Integrated storage box for the device panel
- Powder-painted steel frame
- Suitable for storing training sets, test leads etc.
- Plastic mat

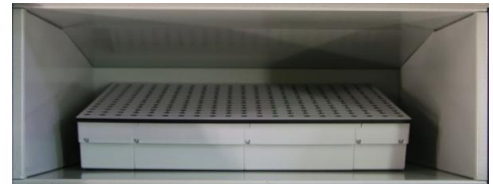

Model	Internal dimensions
STRBOX125	105 (W) x 380(D) x 180(H) mm
STRBOX250	235 (W) x 380(D) x 180(H) mm
STRBOX375	355 (W) x 380(D) x 180(H) mm
STRBOX500	480 (W) x 380(D) x 180(H) mm

DEVBOX

Device box

- Device box for placing portable instruments into the device panel
- 1 pc schuko socket at the rear (other socket types available)
- Opening at the rear for data cables
- Plastic mat



Model	Internal dimensions
DEVBOX375	355 (W) x 380(D) x 180(H) mm
DEVBOX500	480 (W) x 380(D) x 180(H) mm

DYM410

Digital multimeter

- 3 ¾ digit display 3999 steps
- Basic accuracy $\pm 0,5\% + 2$ digits
- Diode measurement and continuity testing
- Hold measurement.
- Relative measurement
- Duty cycle (%) measurement
- Temperature measurement with K type Thermocouple
- Backlit Facility
- Equipped with AC/DC power supply
- Fuse at the front panel
- Standard accessories: manual, cable set
- Dimensions: ½-module, 125(W) x 200(H) mm



	Ranges	Best resolution	Best accuracy, \pm (a % of reading + b digits)
DC voltage	100 μ V - 1000 V	0.001 mV	0.5 % + 2
AC voltage	100 μ V - 1000 V	0.001 mV	1 % + 5
DC current	10 μ A - 10 A	0.01 μ A	0.8 % + 2
AC current	10 μ A - 10 A	0.01 μ A	1 % + 5
Resistance	100 m Ω - 40 M Ω	0.01 Ω	0.8 % + 2
Capacitance	1 pF - 200 μ F	0.001 nF	0.5 % + 3
Frequency	1 Hz - 500 kHz	0.001 Hz	0.2 % + 2
Temperature	0... +1300 $^{\circ}$ C	1 $^{\circ}$ C	2 % + 3

FLUKE175, FLUKE177, FLUKE179

Digital multimeter

- 3 ¾ digit display, max. reading 6000
- Bar graph and backlight (FLUKE177, FLUKE179)
- True-rms AC voltage and current for accurate readings on all waveforms
- Audible continuity and diode test
- Automatic / manual selection of range
- Display hold and autohold
- Max / min / average -recording mode with min / max -alert
- Smoothing mode for filtering rapid changes in input
- Equipped with power supply
- Fuse at the front panel
- Standard accessories: manual, test leads 80BK temperature probe (FLUKE179)
- Dimensions: ½-module, 125(W) x 200(H) mm



	Ranges	Max. resolution	Best accuracy, \pm (a % of reading + b digits)		
			FLUKE175	FLUKE177	FLUKE179
DC voltage	600 mV...1000 V	0.1 mV	$\pm 0.15\% + 2$	$\pm 0.09\% + 2$	$\pm 0.09\% + 2$
AC voltage	600 mV...1000 V	0.1 mV	$\pm 1.0\% + 3$	$\pm 1.0\% + 3$	$\pm 1.0\% + 3$
DC current	60 mA...10 A	0.01 mA	$\pm 1.0\% + 3$	$\pm 1.0\% + 3$	$\pm 1.0\% + 3$
AC current	60 mA...10 A	0.01 mA	$\pm 1.5\% + 3$	$\pm 1.5\% + 3$	$\pm 1.5\% + 3$
Resistance	600 Ω ...50 M Ω	0.1 Ω	$\pm 0.9\% + 1$	$\pm 0.9\% + 1$	$\pm 0.9\% + 1$
Capacitance	1000 nF...9999 μ F	1 nF	$\pm 1.2\% + 2$	$\pm 1.2\% + 2$	$\pm 1.2\% + 2$
Frequency	100 Hz...100 kHz	0.01 Hz	$\pm 0.1\% + 1$	$\pm 0.1\% + 1$	$\pm 0.1\% + 1$
Temperature,	40 $^{\circ}$ C...+400 $^{\circ}$ C	0.1 $^{\circ}$ C	NA	NA	$\pm 1.0\% + 10$

FLUKE17xx serie is not compatible with HELP3- and HELP6 workstations

FLUKE115**Digital multimeter**

- Large white LED backlight to work in poorly lit areas
- True-rms for accurate measurements on non-linear loads
- Measures 20 A (30 seconds momentary; 10 A continuous)
- Resistance, continuity, frequency and capacitance
- Min/Max/Average to record signal fluctuations
- CAT III 600 V safety rated
- Dimensions: ½-module, 125(W) x 200(H) mm



	Ranges	Max. resolution	Best accuracy, ± (a % of reading + b digits)
DC voltage	600 V	1 mV	±0.5 % + 2
AC voltage	600 V	1 mV	±1.0 % + 3
DC current	10 A	1 mA	±1.0 % + 3
AC current	10 A	0.01 A	±1.5 % + 3
Resistance	40 MΩ	0.1 Ω	±0.9 % + 1
Capacitance	10000 μF	1 nF	±1.9 % + 2
Frequency	50 kHz	0.01 Hz	±0.1 % + 2

DYM1908PP**Digital multimeter**

- 5.5 digit resolution, dual display and dual measurement capability
- High accuracy and resolution: 0.02%, 1nA, 1mW, 100nA
- Frequency, capacitance and temperature measurements
- Wide true RMS AC; AC + DC measurements
- 2 or 4 terminal ohms measurement
- Wide true RMS AC; AC + DC measurements
- Software for remote control and logging included
- USB, RS232 and LAN (LXI) interfaces, GPIB optional
- Dimensions: full module, 250(W) x 200(H) mm



	Ranges	Best resolution	Best accuracy *(%)
DC voltage	100 mV...1000 V	1 μ V	0.02 \pm 3 digits
AC voltage (TRMS)	100 mV...750 V	1 μ F	0.2 \pm 200 digits
DC current	10mA...10 A	100 nA	0.05 \pm 5 digits
AC current (TRMS)	10 mA...10 A	100 nA	0.5 \pm 20 digits
Resistance	100 Ω ...10 M Ω	10 m Ω	0.05 \pm 8 digits
Frequency	100 Hz...100 kHz	0.01 Hz	0.01 \pm 1 digit
Capacitance	10 nF...100 μ F	10 pF	2 \pm 5 digits
Temperature	-50 $^{\circ}$ C...+400 $^{\circ}$ C	0.1 $^{\circ}$ C	0.05 \pm 0.5 $^{\circ}$ C

Continuity and Diode Test

Continuity: 100 Ω range selected; audible tone sounds for impedance <10 Ω

Diode Test: Test current approximately 1mA; displays voltages up to 1.2V

Max. O/C Voltage: 3.5V

Maximum Input: 1000V DC or AC rms, any range

Digital Interfaces

Full digital remote control facilities are available through the RS232, LAN, USB and GPIB interfaces. (AC line power is required for RS232, LAN and GPIB interfaces.)

RS232: Standard 9-pin D-connector. Baud rate 9600.

USB: Standard USB 2.0 hardware connection. Host powered.

LAN: Ethernet 100/10base-T hardware connection.

LXI Conformance: 1.4 LXI Core 2011.

GPIB (optional): Conforms with IEEE488.1 and IEEE488.2.

Remote Command

Processing Time: Typically <100ms.

Software supplied

IVI Driver: An IVI driver for Windows is supplied.

LV/CVI Driver: Full installation for CVI and LabVIEW instrument drivers.

USB Driver: An installation file is supplied calling a standard Windows*

LCR55A

LCR meter/Component tester

- 3 ½ digit. LCD, max reading of 1999
- Display update rate 2.5/sec. nominal
- Plug-in test slots and test leads with threaded alligator clips
- Data Hold and Max Hold
- "Zero Adjust" Pot for Ohms
- Standard accessories: TL36A, test leads, 1 pair alligator clips, user manual
- Dimensions: 1/2 module, 125(W) x 200(H) mm



	Ranges	Best accuracy, ± (a % of reading + b digits)
Resistance	20 Ω	1.2 % rdg (zero adjust)
	200 Ω	0.5 % rdg + 3
	2 kΩ...2 MΩ	0.5 % rdg + 1
	20 MΩ	2.0 % rdg + 2
Resolution	10 mΩ in 20 Ω range	
Open circuit voltage	20 Ω range: 6.5 V DC	
	200 Ω range: 3.0 V DC	
	All other ranges: 1.2 V DC	
Continuity		
Audible indication	2 kΩ range: Tone at R < 30 Ω	
Response time	approx 800 ms	
Diode test		
Test current	approx. 1 mA	
Test voltage	3.0 V DC	± (1.5 % rdg + 1 dgt)
Display	Forward junction voltage	
Micro wave diode test		
Test current	approx 0.6 mA	
Test voltage	7.0 V DC typical	3.0 % rdg + 1
Display	Forward junction voltage	
Capacitance	200 pF...200 nF	1.0 % rdg + 1
	2 μ F...200 μ F	2.0 % rdg + 1
	200 μ F < 1000 μ F	3.0 % rdg + 3
	1000 μ F > 2000 μ F	5.0 % rdg + 5
Test frequency	200 pF to 2 μ F: 1000 Hz	
	20 μ F...200 μ F: 100 Hz	
	2000 μ F: 10 Hz	
Temperature coefficient	< 0.5 μ F: 0.1%/°C	
	0.5 μ F: 0.2%/°C	
Inductance	200 μ H	5.0 % rdg + 30
	2...200 mH	3.0 % rdg + 20
	2 mH...200 H	5.0 % rdg + 20
Test frequency	200 μ H... 2 H ranges 1000 Hz	
	20 to 200 H ranges 100 Hz	
Temperature coefficient	< 0.5 H: 0.2%/°C	
	> 0.5 H: 0.5%/°C	
Transistor test		
hFE range	0...1000	
hFE base current	3 μ A approximately	
hFE voltage C - E	3.0 V DC approximately	
Iceo range, leakage current	10 nA...20 μ A	
Overload protection		
Resistance	350 V DC or AC RMS	
Capacitance	0.1 A/250 V fast acting fuse	
Continuity	350 V DC or AC RMS	
Diode test	350 V DC or AC RMS	
Micro wave diode test	350 V DC or AC RMS	
Inductance	0.1 A/250 V fast blow fuse	

FGTG315

Function generator

- 0.03 Hz to 3 MHz frequency range
- Waveforms: sine, square, triangle, DC, symmetry
- Simultaneous display of frequency & amplitude, 4 digit resolution
- Very high waveform quality at all frequencies & levels
- 2mV to 20V pk-pk from 50 Ω or 600 Ω
- Auxiliary TTL/CMOS output
- Variable symmetry with constant frequency
- Variable DC offset with zero detent
- 1000:1 frequency change by vernier or sweep voltage
- Precision internal linear or logarithmic sweep
- Internal or external amplitude modulation
- Attenuator Ranges: 0dB, -20dB, -40dB, -60dB
- Input voltage: 110-120 V / 220-240 V AC, 50/60 Hz
- Standard accessories: power cord, instruction manual
- Dimensions: 1 ¼ module, 312.5(W) X 200(H) mm



FGTG330

Function generator

- 0.03 Hz to 3 MHz frequency range
- Waveforms: sine, square, triangle, DC, symmetry
- Simultaneous display of frequency & amplitude, 4 digit resolution
- External 7 digit 120MHz frequency counter
- Very high waveform quality at all frequencies & levels
- 2mV to 20V pk-pk from 50 Ω or 600 Ω
- Auxiliary TTL/CMOS output
- Variable symmetry with constant frequency
- Variable DC offset with zero detent
- 1000:1 frequency change by vernier or sweep voltage
- Precision internal linear or logarithmic sweep
- Internal or external amplitude modulation
- Attenuator Ranges: 0dB, -20dB, -40dB, -60dB
- Input voltage: 110-120 V / 220-240 V AC, 50/60 Hz
- Standard accessories: power cord, instruction manual
- Dimensions: 1 ¼ module, 312.5(W) X 200(H) mm



FGTGF4000 series

Function generator

- Max. frequency range 40 - 240 MHz sine
- Max. frequency range 25 - 100MHz square/pulse
- Vertical bits/sample rate 14 bits/400 MSa/s or 16 bits/800 MSa/s
- Noise bandwidth 50 - 100 MHz
- Waveforms: Sine, Square, Ramp (Variable Symmetry), Triangle (50% Ramp symmetry), Positive Ramp (100% Ramp symmetry), Negative Ramp (0% Ramp symmetry), Pulse, Noise (Gaussian), DC, Sin(x)/x, Exponential Rise, Exponential Fall, Logarithmic Rise, Logarithmic Fall, Haversine, Cardiac, Gaussian, Lorentz, D-Lorentz and 4 User Defined Arbitrary Waveforms.
- 125 MHz frequency counter/timer with 5 measurement modes
- Programmable via USB and LAN (LXI) interfaces; GPIB optional
- Front USB host socket for waveform storage and file transfers using Flash drives
- High sine wave purity with low phase noise and jitter, audio band THD down to 0.05%
- Two identical channels - independent or linked with coupled and tracking modes
- Harmonics generation using up to 16 harmonics
- Waveform Manager Plus for Windows, editing software included
- Input voltage: 110-120 V / 220-240 V AC, 50/60 Hz
- Standard accessories: power cord, instruction manual
- Dimensions: 1 module, 250(W) X 200(H) mm



	FGTGF4042	FGTGF4082	FGTGF4162	FGTGF4242
Channels	2	2	2	2
Max. frequency range, (sine)	40 MHz	80 MHz	160 MHz	240 MHz
Max. frequency range, (square)	25 MHz		100 MHz	
Vertical bits/Sample rate	14 bits / 400Msa/s		16 bits / 800Msa/s	
Noise bandwidth	50 MHz		100 MHz	

AFG1000 series

Arbitrary / function generator

- Dual-channel, 25 MHz or 60 MHz sine waveforms, 12.5 MHz or 30 MHz square waveforms
- 14 bits, 125 MS/s or 300 MS/s arbitrary waveforms with 8 k points or 1 M points record length
- Amplitude 1 mVp-p to 10 Vp-p into 50 Ω loads
- Continuous, sweeping, burst, and modulation modes (AM, FM, PM, ASK, FSK, PSK, PWM) covers most requirements for students and other users to get the experiments/test job done
- 64-MByte internal non-volatile memory for arbitrary waveform storage
- Standard USB host/device for memory expansion and remote control
- Free ArbExpress makes user defined waveforms editing extremely easy through an external USB memory stick
- Standard accessories: Safety and Compliance Instructions, Documentation CD, Certificate of calibration; USB cable x 1, Type A to Type B, BNC cable x 2, Fuse, cartridge (5 x 20 mm, 0.5 A, 250 V, time-delay) Fuse, cartridge (5 x 20 mm, 1 A, 250 V, time-delay)
- Dimensions: full module, 250(W) x 200(H) mm
- Options
 - **USB1BT** USB connection for instrument panel



	AFG1022	AFG1062
Channels	2	2
Frequency range, sine wave	1 μ Hz to 25 MHz	1 μ Hz to 60 MHz
Display	3.95-inch, resolution 480 by 320, colors 65,536	
Waveforms	Sine, Square, Pulse, Ramp, Noise, and 45 frequently used arbitrary waveforms	
Amplitude into 50 Ω	1 mVp-p to 10 Vp-p	1 mVp-p to 10 Vp-p (\leq 25 MHz), 1 mV p-p to 5 V p-p ($>$ 25 MHz)
Frequency setting resolution	1 μ Hz or 12 digits	
Memory depth	64 MByte	
Arbitrary waveform sample rate	125 MS/s	300 MS/s
Arbitrary waveform vertical resolution	14 bits	

TBS1000C

Digital storage oscilloscopes

The TBS1000C digital storage oscilloscope series is designed specifically to meet the needs of today's schools and universities. It's the first oscilloscope to use an innovative new Courseware system that enables educators to seamlessly integrate teaching materials onto TBS1000C oscilloscopes.

The Courseware information is presented directly on the oscilloscope display and can be used to provide; step by step instructions, background theory, hints and tips or an efficient way for students to document their lab work.



- 7 inch WVGA (800X480) Active TFT Color Display
- 32 automated measurements
- Dual window FFT, simultaneously monitors both the time and frequency domains
- Integrated Courseware feature: Lab content can be loaded directly onto the oscilloscope, Students can review lab content, perform step-by-step instructions, record lab results and create lab reports all on the scope
- Dual channel frequency counter
- Zoom Function
- Advanced triggers including pulse and line-selectable video triggers
- Autoset and signal auto-ranging. Autoset enable/disable feature with password protection
- USB 2.0 host port on the front panel for quick and easy data storage
- USB 2.0 device port on rear panel for easy connection to a PC
- Multiple language user interface
- Dimensions: 1¾-module, 437.5(W) x 200(H) mm
- Standard accessories
 - Passive probes (one per channel)
 - OpenChoice Software
 - CD including: Courseware Editor software, Example Courseware labs, oscilloscope tutorials (TBS1000C only)
 - Traceable certificate of calibration - NIM/NIST
- Recommended accessories
 - **USB1BT** USB connection

	TBS1052C	TBS1072C	TBS1102C	TBS1202C
Channels	2	2	2	2
Bandwidth	50 MHz	70 MHz	100 MHz	200 MHz
Sample rate (each channel)	1 GS/s	1 GS/s	1 GS/s	1 GS/s
Record length (each channel)	20 k points	20 k points	20 k points	20 k points
Vertical resolution	8 bits	8 bits	8 bits	8 bits
Vertical sensitivity	1 mV - 10 V / DIV			
Time base range (s/div)	2 ns - 100 s			

PM3

3 phase power analyzer

The PM3 power analyzer is a multi-purpose measuring device for testing and analyzing 3- and 1- phase devices.

The unit is easy to use. The supply voltage is connected to the device which is under testing via the analyzer and select the desired measurement quantities.

The most common measurement quantities can be stored in shortcuts.

Power analyzer with 85 different measurement parameters and 28 measurement views.

- TRMS 31. harmonic analysis
- Energy counter
- Phase angles display
- Graphical power display
- Connections with 4mm safety terminal screws
- Large backlighted LCD display
- Dimensions: ¾-module, 187.5(W) x 200(H) mm



PM3, PM3A	Ranges	Best accuracy a % of reading
AC voltage	100 VLL-600 VLL (57VLN-346VNL)	0.5
AC current	0-25 A	0.5
Power	-	1
Power factor/power angle	-	3
Frequency	45-65 Hz	0.2
Energy, active	-	0.5
Energy, reactive	-	1
THD	-	3

PM3A

3 phase power analyzer

The PM3A power analyzer is a multi-purpose measurement accessory for testing and analyzing 3 and 1 phase devices. The device is easy to use, it is pre-connected to the output of the power supply and only select the desired measurement quantities.

The most common measurement quantities can be stored in shortcuts.

Power analyzer with 85 different measurement parameters and 28 measurement views



- TRMS 31. harmonic analysis
- Energy counter
- Phase angles display
- Graphical power display
- Large backlighted LCD display
- Dimensions: ¾-module, 187.5(W) x 200(H) mm
- Different versions of power analyzers:
 - **PM3A** Power analyzer for 3-phase up to 25 A current
 - **PM3AB** Power analyzer for 1- and 3-phase using less than 5 A current
 - **PM3A1** Power analyzer for 1-phase up to 25 A current
 - **SULOCK** Key switch for analyzer

ME9000

Multifunction calibrator

65 ppm AC/DC multifunction calibrator designed specifically for calibration of 3½ and 4½ digit multimeters. 1050 V, 20.5 A, resistance, capacitance and temperature packed inside ultra .

USB as standard, Ethernet and IEEE488 interfaces (optional) enable remote control and automation in calibration labs as well as industrial test rigs. The ME9000 is fully compatible with calibration SW package CALIBER/WinQBase, including CamOCR Camera Readout Module which makes handheld multimeter calibration incredibly effective.



DC/AC voltage

- Voltage range summary DC 0 mV - 1050 V
- AC sine 1 mV - 1050 V
- Non-sine 1 mV_{pk} – 10 V_{pk}
- Internal ranges Auto, 10 mV, 100 mV, 1V, 10 V, 100 V, 1050 V
- Frequency range
 - 10 Hz-100 kHz below 10 V
 - 40 Hz-10 kHz up to 100 V
 - 40 Hz-5 kHz up to 500 V
 - 40 Hz-2.5 kHz above 500 V
- Frequency uncertainty and resolution 5 ppm, 6 digit
- Non-sine waveform types Symmetrical square, ramp up, ramp down, triangle, truntaced sinus 1 kHz max
- Non sine amplitude accuracy 0.21 % of value +0.1 % of range +20 μV_{pk}

Range	% of value + % of range				
	DC	10 Hz-1 kHz	1 kHz-10 kHz	1 kHz -10 kHz	1 kHz -10 Hz
0.0000-10.0000 mV	0.020 + 0.060	0.10 + 0.20	0.20 + 0.30	0.35 + 0.40	0.50 + 0.60
10.000-100.000 mV	0.010 + 0.0060	0.10 + 0.05	0.15 + 0.07	0.30 + 0.15	0.50 + 0.20
0.10000-1.00000 V	0.006 + 0.0010	0.05 + 0.005	0.07 + 0.01	0.15 + 0.04	0.50 + 0.10
1.0000-10.0000 V	0.006 + 0.0005	0.05 + 0.005	0.07 + 0.03	0.15 + 0.08	0.50 + 0.20
10.000-100.000 V ¹	0.006 + 0.0010	0.05 + 0.010	0.15 + 0.03	N/A	N/A
100.00-1050.00 V ²	0.009 + 0.0015	0.07 + 0.020	0.2 + 0.06	N/A	N/A

¹ 100 V range starts at 40 Hz

² 1050 V range is limited to 40-5000 Hz below 500 V and 40-2500 Hz above 500 V

DC/AC Current

- Voltage range sumary DC 0 μA – 20.5 A ⁴
- AC sine 1 μA – 20.5 A ⁴
- Non-sine 100 μA_{pk} – 2 A_{pk}
- Internal ranges Auto, 200 μA, 2 mA, 20 mA, 200 mA, 2 A, 20.5 A⁴
- Frequency range
 - 10 Hz-20 kHz below 200 mA
 - 10 Hz-10 kHz for 200 mA-2A
 - 10 Hz-1 kHz above 2 A
- Frequency uncertainty and resolution 5 ppm, 6 digit
- Non-sine waveform types Symmetrical square, tamp up, ramp down, triangle, truntaced sinus 1 kHz max

- Non sine amplitude accuracy 0.21% of value +0.1% of range +700 nA_{pk}

Range	% of value + % of range				
	DC	10 Hz-1 kHz	1 kHz-5 kHz	5 kHz -10 kHz	10 kHz -20 kHz
0.000-200.000 μ A	0.040 + 0.010	0.15 + 0.05	0.20 + 0.10	0.30 + 0.10	0.50 + 0.20
0.2000-2.00000 mA	0.020 + 0.005	0.10 + 0.010	0.10 + 0.02	0.15 + 0.02	0.30 + 0.05
2.0000-20.0000 mA	0.015 + 0.003	0.07 + 0.005	0.10 + 0.02	0.15 + 0.02	0.30 + 0.05
20.0000-200.0000 mA	0.015 + 0.003	0.07 + 0.005	0.10 + 0.02	0.15 + 0.02	0.30 + 0.05
0.2000-2.0000 A ¹	0.015 + 0.005	0.10 + 0.005	0.15 + 0.05	0.30+0.05	N/A
2.000-20.500 A ^{*4,5}	0.05 + 0.01	0.20 + 0.015	N/A	N/A	N/A

⁴ 20.5 A range is optional

⁵ 30 min-5 min maximum continuous output time. Depleted time regenerates 2x slower

Frequency

- Frequency range 0.10000 Hz-2.00000 MHz (unspecified to 20 MHz)
- Frequency accuracy 5 ppm
- Waveform type Positive 5 V_{pk}, 1 V_{pk}, 100 mV_{pk}
- Amplitude accuracy 20 %

Duty cycle

- Frequency range 0.1 Hz up to 1 kHz (accuracy 5 ppm)
- Range 0.1 % up to 99.9 % (accuracy 0.05 %)
- Voltage range 1 mV-14.1 V_{pk} (accuracy 0.5 %+100 μ V)

Temperature TC

- Thermocouple types B.C.D.E.G₂.J.K.M.N.R.S.T
- TC cold junction compensation Manual or automatic with adapter 91
- Uncertainty 0.18°C-0.96°C in TC

RTD temperature sensor simulation (4W)

Type	Range	Accuracy
Pt100-Pt1000	-200.0-0.000 °C	0.15 °C
Pt100-Pt1000	-0.001-850.000 °C	0,2 °C
Ni100-Ni1000	-60.0-300.0 °C	0,1 °C

- Dimensions: 500(W) x 200(H) mm
- Options:
 - ME9000_0950 Current coil x10/x25/x50 <1500A for M9000P
 - ME9000_20A 20A High Current extension for ME9000P
 - ME9000_PT100 Pt100 cold junction compensator ME9000P
 - ME9000_RC RC Resistance and Capacitance Simulator extension for ME9000P
 - ME9000GPIB_ETH GPIB and Ethernet extension for ME9000P
 - M143SW Calibration software
 - M143WINGBASE Database software

POA10A

Adjustable compressed air supply

- Regulated precision air supply
 - Three selectable outputs:
 - Output 1: network pressure
 - Output 2: 1.4 bar, constant
 - Output 3: 0.15-10.00 bar, adjustable
 - Outputs 1 and 3 equipped with analog pressure gauges, 0-10 bar
 - Sensitivity 0.3 mbar
 - Flow capacity 68 m³ / h
 - Solenoid valve in the supply
 - All connections with snap-on connectors, 6/4 mm male connector as standard
- Dimensions: ½ module, 125(W) x 200(H) mm



VP100

Precision vacuum regulator

The VP100 vacuum regulator provides precise control up to full vacuum. The push type locking knob provides smooth adjustment.

- Regulating Range 0 to 30 in.Hg (-100 to -1.3 kPa)
- Sensitivity 0.5 in w.c. (0.13 kPa)
- Flow rate (max.) 100 SCFH (47 NI/min)
- All connections with snap-on connectors, 6/4 mm male connector as standard
- Need electrical vacuum pump VP4 or other vacuum air supply
- Dimensions: ½ module, 125(W) x 200(H) mm



VP4

Electrical vacuum pump

- Mains supply: 230 V 50 Hz (p/n 9427230), 110 V 60 Hz (p/n 9427110)
- Nominal motor rating: 0.1 kW
- Nominal motor speed: 2700 min⁻¹ (50 Hz), 3200 min⁻¹ (60Hz)
- Ultimate vacuum: 7 mbar
- Nominal displacement: 4 m³/h
- Sound level (DIN 45635): 59 dB (A)
- Oil filling: 0.06 l
- Oil: standard hydraulic oil, viscosity 32 (ISO)
- Weight: 5.1 kg
- Dimensions: 133(W) x 141(H) x 230(D) mm (230 V 50 Hz), 148(W) x 141(H) x 230(D) mm (110 V 60 Hz)
- Mains lead: without plug (to be added depending on the installation)
- Options
 - VACUUMPUMPJ Bracket for pump in Concept workstation
 - WHV860575 Bracket for pump in Concept electric workstation



DB

Decade boxes

DBRS, DBLS and DBLC series include decades for resistance, inductance and capacitance.

- Direct reading – No fumbling with multiple slide or rotary switches
- The IET family of digital substituters uses convenient side-by-side thumbwheel switches. Simply dial in the desired values and use
- For easy value readings, ranges are separated by color coded switches and numbers.
- Accuracies of 0.1%, 1.0 % and 2.0 %



Product	Description	Range	Resolution	Accuracy	Dimensions
DBRS201W	Resistance decade	0 – 100 MΩ	0.1 Ω	± (0.1 % + 36 mΩ)	¾-module, 187.5 x 200 mm
DBRSB8WC	Resistance decade	0 – 1 MΩ	0.01 Ω	± 0.1 %	¾-module, 187.5 x 200 mm
DBLS400	Inductance decade	0 – 10 H	1 mH	± (2 % + 0.5 μH)	¾-module, 187.5 x 200 mm
DBCS301	Capacitance decade	0 – 100 μF	100 pF	± (1 % + 3 pF)	¾-module, 187.5 x 200 mm
DBCS301L	Capacitance decade	0 – 10 μF	1 pF	± (1 % + 3 pF)	¾-module, 187.5 x 200 mm
DBRSRTD	RTD-simulator	0.01 ohm- 10 kohm	10 mΩ (0.025 °C PT 100)	0.1%+25 mΩ (± 0.32 °C at 0°C PT 100)	½ -module, 125.0 x 200 mm

VG200

Current and voltage generator

VG200 is a variable constant current and constant voltage source with output and measurement part. VG200 is designed especially for the calibration of measuring instruments, sensors and transmitters.

- Equipped with a 4.5 digit LCD display
- Selection of current and voltage ranges with a switch
- Short-circuit protection and galvanic isolation
- Output
 - Current ranges: 0-20 mA, 0-50 mA, 0-200 mA, stepless adjustment, best accuracy $\pm 0.08\%$
 - Voltage range: 0-200 mV, accuracy $\pm 0.06\%$
 - Capacity: 50 mA DC into a $350\ \Omega$ load, 200 mA DC into a $100\ \Omega$ load
- Measurement
 - Current range: 0-200 mA DC, accuracy $\pm 0.1\%$
 - Voltage range: 0-200 mV DC, 0-20 V DC, best accuracy $\pm 0.06\%$
- Dimensions: $\frac{1}{2}$ module, 125(W) x 200(H) mm



CALABTRK

Process instrument kit for calibration

The process instrument kit includes different type of sensors and transmitters for temperature and pressure calibration. Process instrument kit is applicable e.g. for following training areas

- Calibration of process instruments such as
 - Pressure transmitters, switches and gauges
 - Temperature transmitters, thermocouples, RTDs
- HART, FOUNDATION Fieldbus
- Pressure and temperature calibration
- Documenting and management of calibrations

Contents

- Background material about calibration
 - How to calibrate
 - Process instruments
 - Instrumentation
 - Traceability etc.
- Hands on training exercises
 - Connections between transmitters and calibrators
 - Calibrating, tuning, testing, tuning with HART (pressure and temperature)
- Pressure transmitter:
 - HART® type: 0-10 bar, 4-20 mA. Including pressure connector to MC6 hose set
- Temperature transmitter with Pt100 sensor
 - HART® type: 0-800 °C, 4-20 mA, PT100 (385)
 - Pt100 (385) sensor, 6 mm
- Temperature transmitter
 - FOUNDATION Fieldbus (OPTION)
- Pressure switch
 - Pressure switch, adjustable switch set point 3-7 bar gauge. Including pressure connector to MC6 hose set
- Thermocouple
 - K-element, 3 mm, including K-element connector
- Case



TISECUTESTPRO

Test instrument for electrical safety

- Test instruments for measuring electrical safety of devices per VDE 0701-0702, IEC 62353 and IEC 60974-43
- Measurements
 - Protective conductor resistance, insulation resistance
 - Protective conductor current, RMS value
 - Touch current, RMS value
 - Device leakage current, RMS value
 - Leakage current from the application part, RMS value
 - Patient leakage current, RMS value
 - PRCD time to trip for 30 mA PRCDs
 - Current, voltage, frequency, active power, apparent power, power factor
- 8 reconfigured test sequences for quickly testing simple operating equipment
- One universal, adjustable test sequence
- One test sequence executed with individual measurements
- Enormous data maintenance and storage concept for automated test sequences and measurements for up to 50,000 data records
- Fast access to measurement and test functions with double rotary switch, direct selection keys and softkeys
- High-resolution, brilliant 4.3" TFT color display
- Unique multiple measurement allows convenient recording of several measuring points
- Comprehensive, legally secure preparation of test reports
- Modern interfaces: for data entry two USBs in the front panel and for data exchange one USB in the panel as option, remote control via PC software possible
- Standard accessories: Test probe (2 m, not coiled), USB cable, plug-on alligator clip, cable set for voltage measuring inputs, calibration certificate, condensed operating instructions, ETC report software
- Dimensions: 1 ½ module, 375(W) x 200(H) mm
- Options:
 - TISECUTESOCKUK UK socket for electrical safety tester
 - Z750A 16 A 3-phase current adapter
 - Z751A Barcode reader



VITV74

Electrical safety tester

- Tests
 - AC/DC Hipot
 - Insulation resistance
 - Ground bond
 - Leakage current measurement
- 4.3" color touch display - easy to use intuitive user interface
- 5 kV AC/DC Hipot, 20 mA max source current
- Ground bond 1-30 A RMS (42 A peak), 100 μΩ resolution
- 100 nano-Amp leakage current resolution
- Test memory stores up to 999 steps and 60 test sequences
- Internal self test fully exercises output and verifies current accuracy
- 150 μs safety shutdown
- Standard accessories: HV test leads, GB test leads, operator's manual CD, traceable calibration certificate
- Dimensions: 1 ¼ module, 312.5(W) x 200(H) mm
- Options:
 - USB1BT USB connection
 - VITTL-TPI High voltage test pistol
 - VITHVW7 High voltage warning light
 - VITQTVPRO7 Test automation software



Test	Output range	Measurement accuracy
AC Hipot	10-5000 V, 50/60 Hz, max. 20 mA	Leakage current: 1.5 % of rdg + 5 μA
DC Hipot	20-5000 V, max. 10 mA	Leakage current: 1.5 % + 1 μA
Insulation resistance	20-5000 V DC	Resistance: 150 kohm - 450 Gohm, best accuracy: 2 %
Ground bond	1-30 Arms, 50/60 Hz	Resistance: 0-4.5 ohm, best accuracy: ± 1 mohm

AMTACH20

Tachometer

- Measures rotational and surface speed
- Built-in memory
- Digital display
- Auto power off function
- Easy to select units and mode functions
- Contact and non-contact measurement
- Select rpm using infrared beam or adapter: m/min, m/sec, ft/min, ft/sec, in/min, m, ft, and in
- Measuring ranges rpm:
 - Optical: 1- 99999 min
 - Mechanical: 1- 19999 min
- Optical sensing distance: max. 600 mm
- Accuracy: ± 0.02 % of reading + 1 digit
- Dimensions: 60(W) x 28(D) x 175(H) mm
- Includes 6 adapters, carrying case, reflective tapes, batteries and user manual



FLUKE805

Vibration meter

- Four-level scale for indicating severity of problems for overall vibration and bearing condition
- Exportable data via USB
- Trending in Microsoft® Excel using built-in templates
- Overall vibration measurement (10 Hz to 1,000 Hz) for acceleration, velocity and displacement units of measurement for a wide variety of machines
- Crest Factor+ technology provides reliable bearing assessment using direct sensor tip measurements between 4,000 Hz and 20,000 Hz
- Colored lighting system (green, red) and on-screen comments indicate how much pressure needs to be applied to take measurements
- Infrared temperature sensor
- On-board memory for 3,500 measurements
- Audio output for listening to bearing tones directly
- External accelerometer support for hard to reach locations
- Flashlight
- Dimensions: 71(W) x 58(D) x 241(H) mm



SSLF2900

Soldering station

- Especially designed for lead-free soldering
- Power: 100 W
- $\pm 3^{\circ}\text{C}$ temperature stability
- Temperature adjustable 100-500 $^{\circ}\text{C}$
- 32 VAC hi-recovery nichrome heating
- Auto power down after 15 minutes of idling
- 45 second ramp time to max temp setting
- LCD display which shows the temperature set and the current temperature (in $^{\circ}\text{C}$)
- High quality housing ESD Safe Replaceable Soldering iron with a plug (detachable from base station)
- Pre-setting function for 3 temperatures
- All controls operate are on the LCD display screen
- Includes soldering station, soldering iron and stand for the iron
- Standard tip: SDK601
- Dimensions: $\frac{3}{4}$ -module, 187.5(W) x 200(H) mm

Options

- SDKSDSERIE Tip serie, 4 pcs



SSWT1012SET

Soldering station

- Power: 80 W
- Channels: 1
- Temperature range: 50-450 $^{\circ}\text{C}$
- Temperature accuracy: $\pm 9^{\circ}\text{C}$
- Temperature stability: $\pm 2^{\circ}\text{C}$
- Graphical backlit LC-Display
- Soldering iron:
 - 80 W, 24 V
 - Heat-up time (ca) in seconds (50-350 $^{\circ}\text{C}$): 10
- ESD safe
- Includes: power unit, soldering iron, safety rest and cleaning sponge for soldering iron, soldering tip (2.4 mm)
- Operating voltage: 230 V, 50/60 Hz
- Dimensions: $\frac{3}{4}$ module, 187.5(W) x 200(H) mm
- Options:
 - LT-KIT Soldering tip kit, 5 pcs
 - SSWTCTRL Fume extractor control option



SDLF988D

Soldering/desoldering station

- Combo unit: soldering and desoldering in one system
- Built-in compressor, no need compressed air supply
- Soldering: 32 VAC, 100 W, 150-480°C
- Desoldering: 32 VAC, 100 W, 300-450°C
- Tip temperature stability $\pm 3^\circ\text{C}$
- Vacuum switch located on the desoldering handle
- Delayed suction after switch release for clearing the tubes
- Automatic power down after 15 minutes
- Digital temperature setting and measurement
- ESD safe
- Includes: soldering/desoldering irons, stands for irons, cleaning set
- Standard tips SDK601 and SDKP412L
- Dimensions, full module, 250(W) x 200(H) mm
- Options
 - SDKSDSERIE Soldering tip serie, 4 pcs
 - SDKPDSSERIE Desoldering tip serie 2 pcs
 - SDJTWZ100 SMD -tweezer
 - SDJHAP80 Hot air pencil



SDWR2002

Soldering / desoldering station

- Combo unit with soldering and desoldering functions
- Integrated vacuum pump, no need for compressed air connection
- Power: 250 W
- Temperature range: 50-450 °C (soldering and desoldering)
- Temperature stability: $\pm 2^\circ\text{C}$
- LCD display
- Automatic tool recognition for safe operation with different soldering tools
- 2 independent channels for simultaneous operation with different tools
- ESD safe
- Sleep mode when unit not used
- Includes soldering iron, desoldering iron, stands and cleaning sponges for soldering tools, cleaning tool series, soldering tip (2.4 mm), 3 pcs desoldering nozzles (1.0/2.3 mm, 1.2/2.5 mm, 1.2/2.5 mm thick)
- Dimensions: 1 ¼ module: 312.5(W) x 200(H) mm
- Options:
 - LT-KIT Soldering tip kit, 5 pcs
 - SDDXSRJ Desoldering nozzle set, 6 pcs
 - SDHGPSET Hot air pencil
 - SDR-06 Optional tip for hot air pencil



LT-KIT

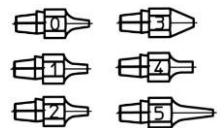

SDDXSRJ



SDHGPSET

SDLF861D

Digital hot air rework station

- Temperature Range: 100 to 500°C
- Power: 1000 Watts
- High quality housing ESD Safe
- Hot air station has three regular channels CH1, CH2 and CH3.
- Each channel parameters including temperature and airflow
- Real time operations by the magnetic switch.
- Large Power, rapid heating.
- Brushless whirlpool motor, wide range and adjustable airflow.
- Automatic cooling system which prolongs the lifetime of the heating element and protects the handle



SDLF861D includes:

- Control Unit
- 8mm Single Pipe Focus Hood
- 6mm Single Pipe Focus Hood
- 5mm Single Pipe Focus Hood
- External Stand w/Auto Shut-Off
- Dimensions: ¾ module, 187.5(W) x 200(H) mm

ELTOOLSET

Electronics tool set

- Professional electronics tool set
- 30 parts
- ESD protected design
- Tools included:
 - Side cutter - oval head
 - Needle nose pliers
 - Tip cutter - angled wide head
 - Ergonomic precision tweezers with straight, strong tips
 - Ergonomic precision tweezers with straight, very pointed tips for gripping fine wires
 - Ergonomic precision tweezers with straight, flat and rounded tips for simple gripping jobs
 - Screwdriver set, precision, ESD, slotted, Phillips
 - Screwdriver set, precision, ESD, hexagon
 - Screwdriver set, precision, ESD, hexagon nut driver
 - Screwdriver set, precision, ESD, TORX



SOLDERSET

Soldering consumables set

- Contents:
 - Solder dispenser, 1 roll
 - Cleaner flux
 - Soldering tip cleaner
 - Solder wick, 1.5 mm
 - Solder wick, 2.2 mm
 - Solder wick, 2.7 mm
 - Flux pen
 - Flux-gel
 - Lead-free solder
 - Desoldering pump



STKIT

Soldering training kit

- Suitable for practicing basic and advanced soldering techniques
- Includes three different type of soldering training kits
 - Soldering training kit "Dice": 16 pcs through-hole components
 - Soldering training kit "SMD ruler", 80 pcs SMD components
 - Soldering training kit "Running light": 30 pcs SMD components
- Assembly instructions included in all training kits



SDTPF

Soldering training package

- Soldering training kits including instructions and components
 - Training kit "SMD ruler", 20 pcs
 - Training kit "SMD lights", 10 pcs
 - Training kit "SMD smiley face", 10 pcs
 - Training kit "Flasher", 10 pcs
 - Training kit "Dice", 10 pcs
 - Training kit "LEDs", 10 pcs
- Vacuum pick up tool
- Tin roll, 0.8 mm
- Flux pen
- Flux remover pen
- Solder paste
- Paste dispenser, 10 pcs
- Standard: ICP-A610: "Acceptability of Electronic Assemblies"
- Infrared thermometer
- Case



SDMICRO

Digital microscope

This high-quality microscope with digital camera and USB interface is a professional solution for tasks with diverse magnification requirements. It is designed to be used in quality control or educational purposes.

The image of the object can be transmitted as a digital photo or video to a PC via the USB cable and displayed in exceptional detail.

- Resolution: 1280 x 1024
- Magnification: 20X - 90X
- Sensor: 1/3" Color CMOS
- Video frame rate: up to 30 Fps
- Illumination: 8 build-in Hightech LEDs
- ESD safe
- Metal stand for microscope, adjustable in all directions
- Software features: picture and video capturing (jpg, bmp, avi), editing and measuring pictures, LED control
- Contents: Microscope with digital camera and USB interface, adjustable work stand and application software



FT91015699

Fume extractor

- Fume extraction unit for 1 workplace
- Fine dust pre-filter can be separately changed without having to change the main filter
- Active carbon foam for effective gas filtration
- Portable fume extraction unit, for placement under or next to the bench
- Quick and easy filter replacement
- Longer service life due to exceptionally large filter surface of 2,4m²
- Variable speed setting
- Automated filter change notification system
- Exceptionally long service life due to maintenance free brushless EC turbine
- Quick, simple and user-friendly installation with Easy-Click System
- ESD safe
- Low noise level: max 50 dB(A) at 1 m
- Suction capacity: 190 m³/h
- Voltage: 220-240 V (50/60 Hz)
- Dimensions: 355(W) x 333(D) x 455(H) mm
- Includes filter unit, stop valve with bench mounting brackets, 3 m extraction hose (ø 60 mm), 1 m extraction arm (ø 60 mm), funnel nose
- Options:
 - **FT3411** Additional extractor arm
 - **58762858** Gas filter and fine dust filter (10 pcs)



SD468ESD

Fume Extractor

- ESD safe
- Power 20-22 W
- Max air volume: 95/115 CFM
- Voltage: 100-120 V (60 Hz). 220-240 V (50 Hz)
- Filter size: 130 mm²
- Dimensions: 182(W) x 136(D) x 200(H) mm
- Weight: 1,168 kg



VALRND550LED

Magnifying lamp, LED

- Glass lens
- Magnification 1.75x
- 3 dioptries
- Super bright 60 Ultra-efficient SMD LEDs
- Equipped with strong internal springs in the arm
- Covered arm for full protection
- Integrated handle for easy positioning
- Lamp head with stainless steel ring for decoration
- Heavy duty metal G-clamp
- Colour Temperature 6000-6500K
- Luminous flux 950 Lumen
- Operating voltage: 220-240 V AC, 50 Hz



VALLOOPLED

Magnifying lamp, LED

- The magnifier lamp is ideal for precise work
The high quality loop 3D + 12D is a versatile powerful LED magnifying glass lamp with a double lens: a large 4" 3D lens (1.75x) with a smaller 12D lens with 4x magnification
- The LED lamps in the luminaire shed a clear and even light. They are long-lived (20000 h) and energy effective
- The lamp stands freely on the table and its power switch is on the stand. With the closable lid pressed on, the lamp also works as a regular workplace lamp
- Colour Temperature 6500K
- Luminous flux 570 Lumen
- Operating voltage: 220-240 V AC, 50 Hz



MULTIPURPOSE HELP3 LABORATORY

TEKLAB HELP3 workstation is based on a unique multipurpose construction, which enables theory lessons and practical training in one room. Thanks to the compact size, laboratories can also be built into normal classrooms with limited space.

HELP3 workstations are an excellent solution for basic electrical engineering laboratories, physics laboratories as well as for teaching the basics of electrical systems to ICT and car technicians and engineers.

MULTIPURPOSE WORKSTATION CONCEPT

HELP3 workstations have modular build-in electrical instruments which can be selected according to customer needs. These instruments can be hidden under sliding table top, which enables transforming the laboratory workstation into a normal theory table. The cover can also be locked offering a safe place for storing the equipment.

Optionally, the workstation cover can be equipped with electric lock with remote control via TEKLAB TLMC laboratory management software.



HELP3 workstation: theory mode



HELP3 workstation: practice mode

SAFE AND PRACTICAL LABORATORY

All TEKLAB workstations are equipped with electrical protection systems for safe working.

As instruments and computer connections are integrated into the workstation, the workspace is practical to use.

Practical design is also aesthetic.



TYPICAL DELIVERY CONTENT

- HELP3 workstations
- Integrated instruments
- Integration place for training kits
- Racks and connections for computers
- Technical furniture (cabinets, drawers, chairs)
- Designing
- Installation and training

MULTIPURPOSE HELP6 LABORATORY

HELP6 motorised multipurpose workstations offer great flexibility for technical laboratories: motorised panels can be driven up and down to transform a theory classroom into a technical laboratory - and vice versa. Considerable savings are achieved thanks to the possibility to modify classrooms for different purposes.

TRAINING AREAS

HELP6 motorised workstations are the right choice e.g. for electronics and telecommunication training laboratories. Together with TLMC laboratory control software, HELP6 workstations convert the laboratory into a multifunctional room.

INTEGRATED CONSTRUCTION

HELP6 workstation is equipped with a modular instrument panel for electrical instruments such as power supplies and measuring equipment. Integration releases more space on tabletop providing an ergonomic workplace.

HELP6 workstation includes also an integrated storage space. This storage space is suitable for storing training sets, learning materials and accessories. When the panels are driven down and locked, the equipment is practically stored in a safe place.

The multipurpose concept brings savings in both space and time because all laboratory equipment and components are always easily available in the workstation.

UNIQUE FUNCTIONALITY

HELP6 laboratory can be controlled via TEKLAB TLMC software on the teacher's computers.

Centralized software control converts the laboratory into a theory classroom in just 30 seconds. Besides this, the teacher can for example:

- Control of the students' motorised workstations (UP / DOWN / LOCK)
- Control of the electricity in the students' workstations (ON / OFF)
- Limit the output voltage and current on power supplies
- Supervise and lock students' computers

Students can control the instruments via TEKLAB Client software. In addition, datalogging features are available for saving measurement results.



HELP6 workstation

WHY LABORATORY BASED ON HELP6 WORKSTATIONS?

- 2 in 1 concept: laboratory work and theory lessons in one room
- All instruments and training equipment available by a press of a button
- Suitable for different types of laboratories:
 - Electrical
 - Electronics
 - Automation etc.



HELP6 laboratory in theory teaching mode. All equipment is safely stored inside the workstations.



HELP6 laboratory in practice mode. All equipment is practically available.

TLMC

TEKLAB Mobile Laboratory Control

Unique TEKLAB Mobile Laboratory Control (TMLC) gives teacher a possibility to control a laboratory remotely using a mobile device such as a tablet or a smart phone.

With TMLC the teacher can:

- Open the laboratory by driving the HELP6 benches up and enabling electricity
- Close the laboratory by switching power off and driving the HELP6 benches down
- Apply voltage and current limitations to power supplies (requires ACP/DCA Client options)

TMLC includes:

- TMLC software
- Tablet device

Code	Description
TMLC	TEKLAB Mobile Laboratory Control



Teacher's mobile device running TMLC software

LABORATORY 2, 3...

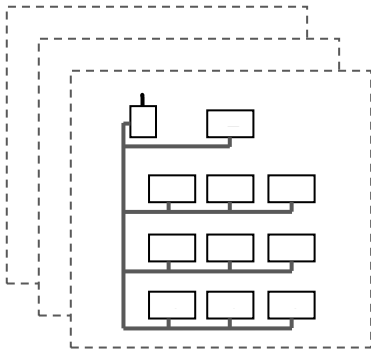

LABORATORY 1

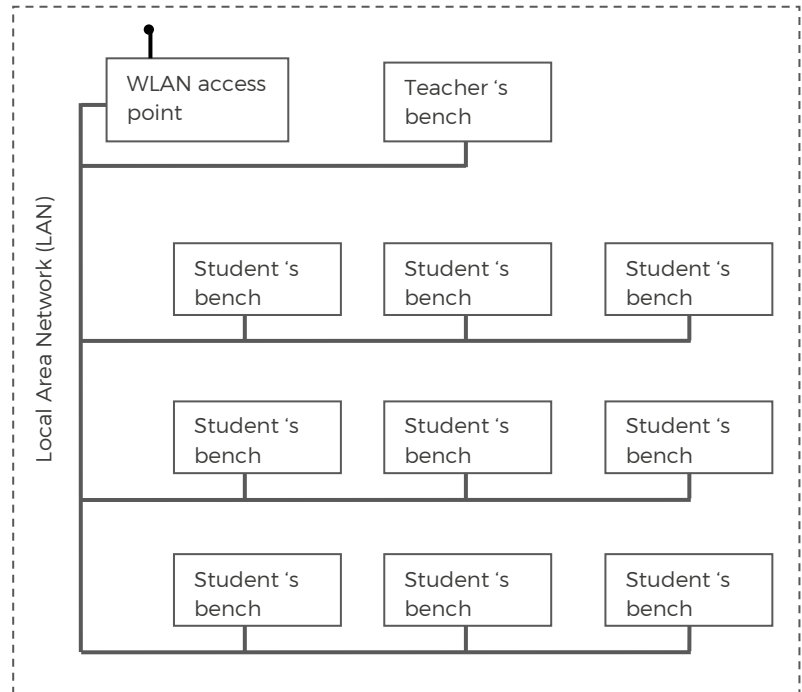

TEKLAB Client software

Software for instrument control

TEKLAB Client software including fast two-way communication and versatile user interfaces enable e.g. automatic measurements without programming.

TEKLAB Client devices are connected to the local network (LAN/WLAN), which enables also central device control via TEKLAB TLMC laboratory management software.

The devices come with uniform user interfaces, both in terms of visual look and operation, including e.g. save functions for set and measured values. The advanced datalogging function enables e.g. simultaneous follow-up and saving of several quantities or saving of an individual value by the snapshot function. The advanced TCP/IP based LabVIEW drivers speed up making own applications. Manual operation is also possible for all devices.



Touch screen control

Software	Description
ACPETHERNET	TCP / IP interface, Client software and LabVIEW driver for ACP series AC power supplies
DCAETHERNET	Ethernet connection and control program for DCACPX400SP

COLOUR OPTIONS FOR LABORATORY

- Choose your own colour scheme for the laboratory
- Colour scheme available for cabinet doors, drawers, workstation sides & back plates and chairs

Model	Description
LABCOLOUR	Colour scheme for the laboratory

LOCKING SYSTEM FOR LABORATORY FURNITURE

- Laboratory fittings can be equipped with 3-level locking system, which can be used to limit access from unauthorized persons

Model	Description
LABLOCK	3-level locking system for fittings

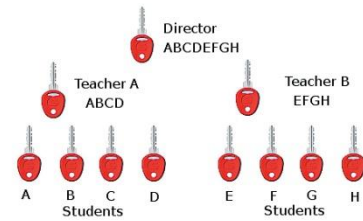

TEST LEAD SETS

Features

- Highly flexible double insulated PVC-lead 2.5 mm²
- Rated voltage: 1000 V CAT II
- Rated current: 32 A
- 4 mm safety connectors

Model	Description
JTESTSET1	Test leads: <ul style="list-style-type: none"> - 3 pcs 1.0 m, black - 3 pcs 1.0 m, red - 1 pcs 1.0 m, green/yellow - 3 pcs 0.25 m, black Test lead holder, wall-mounted
JTESTSET2	Test leads: <ul style="list-style-type: none"> - 2 pcs 1.0 m, black - 2 pcs 1.0 m, red - 2 pcs 1.0 m, yellow/green - 2 pcs 1.0 m, blue - 2 pcs 0.5 m, black - 2 pcs 0.5 m, red Connectors: <ul style="list-style-type: none"> - 2 pcs tweezers, black - 2 pcs tweezers, red - 2 pcs crocodile clip, black - 2 pcs crocodile clip, red - 2 pcs quick-release terminals, black - 2 pcs quick-release terminals, red Storage box
JTESTROLLER	Test leads: <ul style="list-style-type: none"> - 30 pcs 1.0 m, black - 30 pcs 1.0 m, red - 10 pcs 1.0 m, green/yellow - 10 pcs 1.0 m, blue - 10 pcs 0.5 m, black - 30 pcs 0.25 m, black Test lead trolley



JTESTSET2



JTESTROLLER

LABORATORY TOOL PACKAGE

- High speed rotary tool, 8 pcs
 - No-load speed, 10 000 – 33 000 rpm, 10 speed levels
 - Collet lock
 - Twist Nose Cap (no wrench required for changing accessories)
 - Replaceable brushes
 - Soft grip for reduced vibration and a better handling
 - 25 pcs accessories
- Vice, 8 pcs
 - Rubber suction foot
 - Can be swivelled 360° with an adjustable tilt angle of up to 90°
- Circuit board holder, 8 pcs
 - Max. PCB size: 160 x 235 mm
 - Can be rotated by 360°; in 15° steps interlockable
 - PCB assembly with spring holders
 - Turnable arm with clamping pad for keeping the components in place
 - Antistatic construction
- Safety goggles, 24 pcs
 - Frameless design for distortion free vision
 - Cushioned temple pads for superior comfort and grip
 - Clear polycarbonate lens for protection against low energy impact



Model	Description
LABTOOL	Laboratory tool package

MAINTENANCE PACKAGE FOR LABORATORY

- Maintenance package for laboratory
- The maintenance program is designed to keep the laboratory in proper condition
- Regular tests once a year ensure that the work is done comfortably and more safely
- Maintenance program includes:
 - Test reports
 - Safety tester
 - Safety test leads
 - Schuko-plug test cable
 - Digital multimeter
- Program includes e.g. following tests:
 - PE-conductor continuity test
 - Conductor insulation resistance tests
 - Fault loop / RCD test
 - Device tests



Model	Description
LABCHECK	Laboratory maintenance program

SAFETY PACKAGE FOR LABORATORY

- First aid cabinet
 - Cabinet to be fixed to a wall including a variety of first aid products protected against dust and moisture by transparent lids.
 - Blood stoppers
 - Protection kit
 - Triangular bandages
 - Wound cleansers
 - Plaster dispenser + 85 pcs plasters
 - First aid instructions



...asily available and

Model	Description
LABSAFE	Laboratory safety package

ESD PACKAGE FOR LABORATORY

- ESD test station, 1 pc
 - ESD wrist strap and shoe tester
 - Instructions on the panel
 - Wall fastening set
- ESD jackets, 6 pcs
 - Unisex model
 - Semiconductive material
 - Washable without losing conductive properties
- ESD covers for shoes, 100 pairs
 - ESD shields with conducting tape for shoes



Model	Description
LABESD	Laboratory ESD package

TOOL SET FOR INSTALLING WORKBENCH

- Professional tool set for workbench installation
- 10 parts
- Tools included:
 - Long arm hex key, 5.0 mm
 - Long arm hex key, 3/32 inch
 - Long arm Torx key, T10
 - Long arm Torx key, T20
 - Long arm Torx key, T25
 - Long arm Torx key, T30
 - Screwdriver, PZ3
 - Screwdriver, PZ2
 - 13 mm combination spanner, 180 mm
 - 19 mm combination spanner, 250 mm
 - Tool roll for tools, 390x320 mm



Model	Description
INSTOOLSET	Tool set for installing workbench

ESD PROTECTION EQUIPMENT

- Electrostatic discharges cause frequently disturbances in electronic devices. Sensitive components can be destroyed immediately or the fault might come out later.
- TEKLAB offers ESD-protection systems for laboratories and workshops, which help to avoid ESD-based problems.

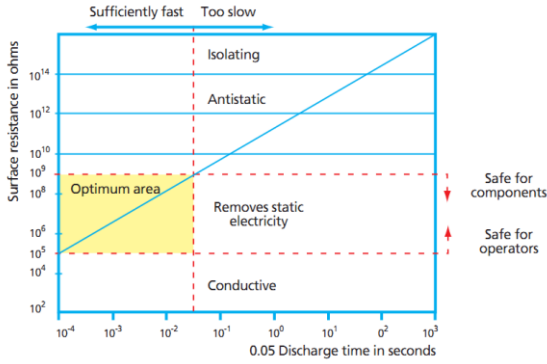

- A Connection box for grounding sets with 1 Mohm resistance
- B Grounding set for the wrist strap, press-stud (male)
2 pcs for 10 mm press-studs
- C Adjustable wrist strap, 2.5 m spiral cord
with 10 mm press-stud
- D ESD-earth to connection box
- E Floor mat 2000 x 1250 mm
- F Grounding set, mat
(for all mats)

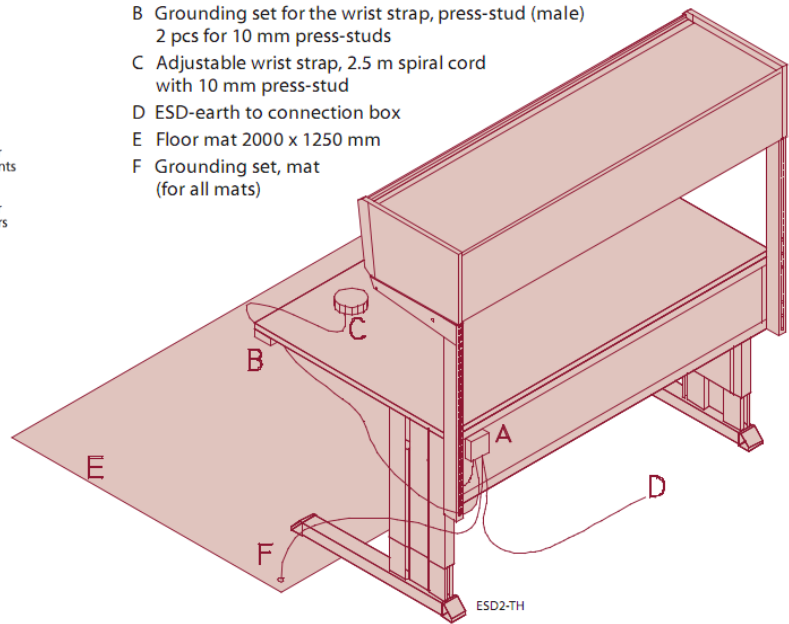

Model	Description
ESDSETI	ESD grounding set for workstation: ESD connection box, workstation frame ESD grounding set, ESD wrist strap grounding set, 2 pcs ESD wrist straps
ESDMATI	ESD floor mat, 2000 x 1250 mm, ESD connection wire
ESDMAT2X2	ESD floor mat, 2000 x 2000 mm, ESD connection wire

BASIC Multipurpose laboratory table

EPHELP



TEKLAB EPHELP workstation is based on a unique multipurpose construction, which enables theory lessons and practical training in one room.

EPHELP workstations are an excellent solution for multiuse STEM and physics laboratories.

EPHELP multifunction workstation is a cost-effective solution for training laboratories. Thanks to the compact size, the laboratory can be built into rooms with limited space.

The EPHELP serie uses its own device module size, see pages 73-79

- Multipurpose construction: electric workstation and theory desk in one solution
- Built-in instrument panel for integrated electrical instruments, instrument panel located under a sliding table top
- Sliding table top movable forwards and backwards to enable / hide the instrument panel
- Sliding table top can be locked to prevent access to the instrument panel
- Modular instrument panel:
 - Devices can be added afterwards (EP15xx and EP20xx modules)
- Instrument panel is slanted to achieve best possible usability
- Workstation frame and instrument panel made of ESD powder painted steel
- L-shaped ergonomic legs for more space under workstation
- Height 770 or 900 mm
- Adjustment screws under the workstation to eliminate the roughness of the floor
- Table top with laminate coating, durable plastic edges, colour light grey

Workstation frames	Workstation size, W x D x H (mm) Top open/close	Table top size W x D (mm)	Module area mm
EPHELP157	1500 x 530-730 x 770	1500 x 500	1400
EPHELP177	1780 x 530-730 x 770	1780 x 500	1700
EPHELP159	1500 x 530-730 x 900	1500 x 500	1400
EPHELP179	1780 x 530-730 x 900	1780 x 500	1700

Options for EPHELP workstations	
HELP3SOCKEU	4 pcs schuko sockets under the workstation
HELP3SOCKUK	4 pcs UK sockets under the workstation
HELP3SOCKUS	4 pcs US sockets under the workstation
EPHELPSHELF9015	Shelf for EPHELP159
EPHELPSHELF9017	Shelf for EPHELP179

BASIC workstation

TABBL, EP15Lxx, EP20Lxx



EP20Lxx panel dimensions

BASIC workstation serie is designed for need of technology training. There are power supplies, soldering stations, multimeters and all necessary sockets and data connections ready to use.

EP15L- and EP20L- panels are easy to fit on any table frame (also on customer's own tables).

Twin tables also belong to product range.

Economical choice for STEM, electrical, automation, physics and base electronics laboratories

The BASIC serie uses its own device module size, see pages 73-79.

- Workstation frame
 - ESD-painted stable steel frame
 - Table top with laminate surface, durable rounded plastic edges, colour light speckled grey
 - Optional ESD-table top,
 - Stepless height adjustment: 650-900 mm
 - Load capacity 300 kg, evenly loaded
- Device panel
 - Device panel for integrated electrical instruments
 - Structure of the panel made of ESD-painted steel
 - Compact design, depth and height only 215 mm
 - Panel equipped with modular device system: Devices can be easily added
 - Device panel is slanted to offer best usability
 - Installed on table top - **compatible with all workstation models**
 - Including changing socket

Workstation frames, standard table top	Workstation frames, ESD table top	Table top size, W x D (mm)
TABBL12	ETABBL12	1200 x 700
TABBL15	ETABBL15	1500 x 700
TABBL18	ETABBL18	1800 x 700
TABBL20	ETABBL20	2000 x 700
Table tops available also with 900 mm depth		

Panels	Panel dimensions, W x D x H (mm)
EP20L15	1500 x 215 x 215
EP20L18	1800 x 215 x 215
EP20L20	2000 x 215 x 215
EP15L12	1200 x 150 x 150
EP15L15	1500 x 150 x 150
EP15L18	1800 x 150 x 150
EP15L20	2000 x 150 x 150

Options for EP20L-models	Description
PANSOCKETLEU	2 x 2 pcs schuko sockets under device panel
PANSOCKETLUK	2 x 2 pcs UK sockets under device panel
PANSOCKETLUS	2 x 2 pcs US sockets under device panel
EPTWIN15	Assembling serie for connecting 2 pcs EP20L15
EPTWIN18	Assembling serie for connecting 2 pcs EP20L18
EPTWIN20	Assembling serie for connecting 2 pcs EP20L20

BASIC Instrument workstation

TABCONH, EP15Lxx, EP20Lxx



The BASIC range is designed to offer the same features as other Teklab workstation models, but in an affordable price range, with a smaller equipment panel and a limited product range. Typical applications in the workstation collection are electrical, electronics and product development facilities.

The BASIC serie uses its own device module size, see pages 73-79.

- Workstation frame
 - ESD-painted stable steel frame
 - L-shaped ergonomic legs, stepless adjustable between 670-1100 mm
 - Height of the upright tube module 1300 mm from table top
 - Versatile and adjustable accessories enable ergonomic and practical working environment
 - Load capacity manually adjustment 500 kg, electrical model 400 kg, evenly loaded
 - Adjustment screws to eliminate the roughness of the floor
 - Table top with laminate surface, durable rounded plastic edges, colour light speckled grey
 - The core of the optional ESD-table top, as well as the laminate of the coating are semi-conductive
- Device panel
 - Device panel for integrated electrical instruments
 - Structure of the panel made of ESD-painted steel
 - Compact design, depth and height only 215 mm
 - Panel equipped with modular device system: Devices can be easily added
 - Device panel is slanted to offer best usability
 - Installed on table top - compatible with all workstation models
 - The instrument panel can also be connected to the same workstation as the PANCONHxx panel
 - Including changing socket

Workstation frames, standard table top		Workstation frames, ESD table top		Table top size, W x D (mm)	
TABCONH15, TABCONH15E		ETABCONH15, ETABCONH15E		1500 x 750	
TABCONH18, TABCONH18E		ETABCONH18, ETABCONH18E		1800 x 750	
TABCONH20, TABCONH20E		ETABCONH20, ETABCONH20E		2000 x 750	
TABCONCH10		ETABCONCH10		Corner workstation	
E = Electrical height adjustment					
EP20L Panels		Panel dimensions, mm		EP15L Panels	
EP20L15		1500 x 215 x 215		EP15L12	
EP20L18		1800 x 215 x 215		EP15L15	
EP20L20		2000 x 215 x 215		EP15L18	
				EP15L20	
				2000 x 150 x 150	
Options EP20L panel			Description		
PANOCKETLEU			2 x 2 pcs schuko sockets under device panel		
PANOCKETLUK			2 x 2 pcs UK sockets under device panel		
PANOCKETLUS			2 x 2 pcs US sockets under device panel		

Note! These device modules are only compatible with BASIC workstations, see pages 70-72

EP15SU1

1 phase supply unit

- Main switch for the workstation with START-position
- Green indicator light
- Integrated emergency switch, reset from the main switch
- Automatic restart prevention system e.g. after power failure
- Fault current protection (30 mA) for all devices connected to the supply unit
- Outlets for the device modules
- Dimensions: 150(W) x 150(H) mm
- Options:
 - **EP15LOCK** Electricity locking module

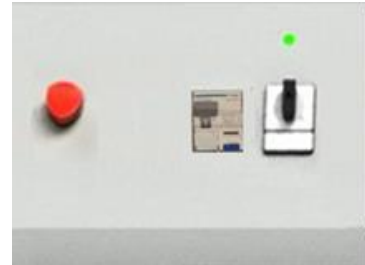

EP15SU3

3 phase supply unit

- Main switch for the whole workstation with START position
- Green indicator light
- Integrated emergency switch, reset from the main switch
- Automatic restart prevention system e.g. after power failure
- Fault current protection (30 mA) for all devices connected to the supply unit
- Thermal overload protectors
- Outlets for the device modules
- Dimensions: 300(W) x 150(H) mm modules
- Options: **EP15LOCK** Electricity locking module

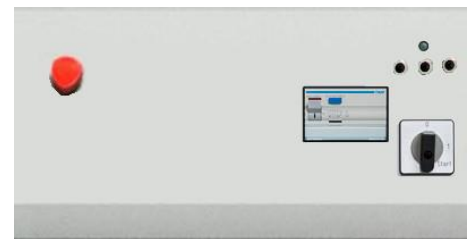

EP15NET

Supply unit control module

- Enables remote control for electricity in the workbench or table groups (requires TLMC software)
- Features
 - Connection permission for power
 - Power off control
 - Power on/off status information
- Key switch for bypassing software control
- Ethernet connection
- Dimensions 100(W) x 150(H) mm



Note! These device modules are only compatible with BASIC workstations, see pages 70-72

EP15LOCK

Electricity locking module

- Electricity locking with key
- Enables electronic locking of one or a group of tables
- Dimensions: 100(W) x 150(H) mm
- Option:
 - Serialization for locks

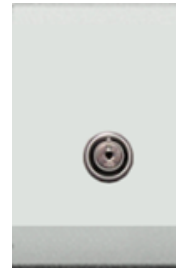

EP15xx

Socket outlets

- Standard models:
 - EP15SCHUKO2 2 x schuko sockets
 - EP152GB 2 x UK-sockets
 - EP152US 2 x US-sockets
 - EP151USB_A_C 1 x schuko socket +1 x USB A and 1 x USB C
5V 3.0A / 9V 2.22A / 12V 1.67A
 - EP151GBUSB_A_C 1 x UK-socket +1 x USB A and 1 x USB C
5V 3.0A / 9V 2.22A / 12V 1.67A
 - EP15CEE3 3-phase socket; CEE, 16 A
- Other socket models also available
- Dimensions: 100(W) x 150(H) mm



EP15DPANEL

USB and Ethernet connections

- EP15DPANEL Connection panel max. 4 connections
- DETH RJ45 connection
- DUSB2_A_C 1 x USB A, 1 x USB C 5V 3.0A / 9V 2.22A / 12V 1.67A
- Dimensions: 100(W) x 150(H) mm



EP15PS3

Safety sockets

- 3 phase safety socket outlet
- 4 mm safety connectors
- 3L+N+PE
- Dimensions: 100(W) x 150(H) mm



Note! These device modules are only compatible with BASIC workstations, see pages 70-72

EP15PO2

Compressed air connection

- Compressed air connection, 10 bar, 2 outputs
- Output equipped with snap-on connectors
- Dimensions: 100(W) x 150(H) mm

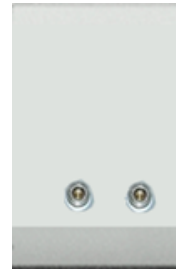

EP15POA

Adjustable compressed air supply

- Adjustable output pressure 0,5-10 bar
- Meter for output pressure
- Output equipped with snap-on connectors
- Dimensions: 200(W) x 150(H) mm



EP15DCA305PS, EPHDCA305PS

Adjustable DC power supply

- Output values: 0-30 V, 0-5 A
- Short-circuit protected
- Stepless adjustment for output voltage
- Stepless adjustment for current limitation
- Measurement of current and voltage
- Output from 4 mm safety terminals
- Dimensions: 250(W) x 150(H) mm
- Dimensions: 100(W) x 150(H) mm (Only for EPHELPxxx tables)



EP15DCF242, EP20DCF242D

Fixed DC power supply

- Output values:
24 V, 2 A (EP15DCF242),
2x24 V, 2 A (EP20DCF242D)
- Output floating
- Ripple: < 50 mVpp
- Short-circuit protected
- Voltage accuracy better than 100 mV
- Output from 4 mm safety terminals
- Dimensions: 100(W) x 150(H) mm

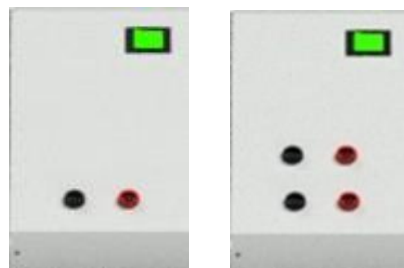

Note! These device modules are only compatible with BASIC workstations, see pages 70-72

EP15DCF153, EP20DCF153D

Fixed DC power supply

- Output values:
12 V, 3 A (EP15DCF153)
2x12 V, 3 A (EP20DCF153D)
- Output floating
- Ripple: < 50 mVpp
- Short-circuit protected
- Voltage accuracy better than 100 mV
- Output from 4 mm safety terminals
- Dimensions: 100(W) x 150(H) mm

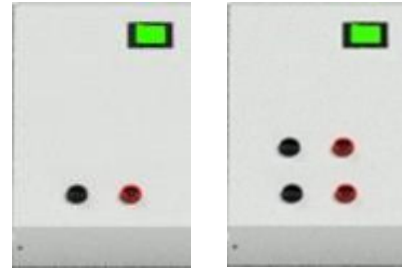

EP15DCF123, EP20DCF123D

Fixed DC power supply

- Output values:
12 V, 3 A (EP15DCF123)
2x12 V, 3 A (EP20DCF123D)
- Output floating
- Ripple: < 50 mVpp
- Short-circuit protected
- Voltage accuracy better than 100 mV
- Output from 4 mm safety terminals
- Dimensions: 100(W) x 150(H) mm

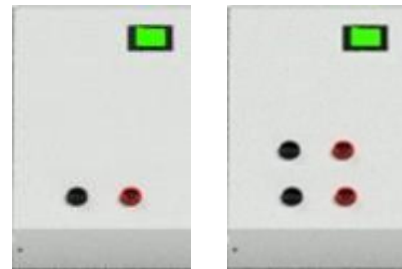

EP15DCF335, EP20DCF335D

EP15DCF55, EP20DCF55D

Fixed DC power supply

- Output values:
3,3 V, 5 A (EP15DCS335), 2x3,3 V, 5 A (EP20DCF335D)
5 V, 5 A (EP15DCF55), 2x5 V, 5 A (EP20DCF55D)
- Output floating
- Ripple: < 50 mVpp
- Short-circuit protected
- Voltage accuracy better than 100 mV
- Output from 4 mm safety terminals
- Dimensions: 200(W) x 150(H) mm

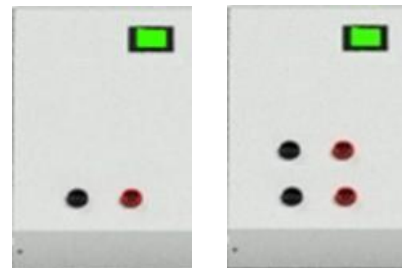

Note! These device modules are only compatible with BASIC workstations, see pages 70-72

EP15ACF242

Fixed AC power supply

- Galvanically isolated AC output
- Output values: 2x24 V, 2 A, max. 100 VA
- Overload protectors for primary / secondary circuits
- Output from 4 mm safety terminals
- Dimensions: 200(W) x 150(H) mm

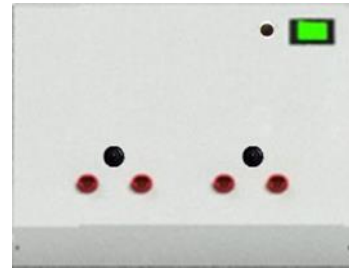

EP15ACF421

3 phase AC connection

- Galvanically isolated AC output
- Output values: 24/42 VAC, 1 A
- Overload protectors for primary / secondary circuits
- Output from 4 mm safety terminals
- Dimensions: 200(W) x 150(H) mm



EP20ACF2302

Isolated 1 phase AC connection

- Galvanically isolated AC outlet
- Output values: 230 V, 2 A, max. 500 VA
- Overload protectors for primary / secondary circuits
- Dimensions: 200(W) x 150(H) mm
- Options:
 - ACF SOCKET UK UK socket for AC outlet
 - ACF SOCKET US US-socket for AC outlet

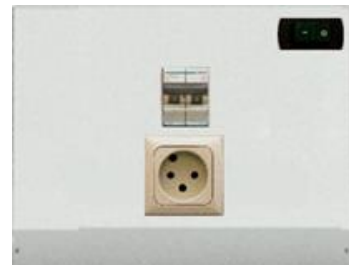

EP20ACA505

1 phase variable AC power supply

- Variable transformer 0-50 V, 5 A AC, 230 VA
- Galvanic isolation
- Overload protection
- Output: 4 mm safety terminals
- Digital meters for output voltage and current
- Voltage measuring: 0-10 V AC, best resolution 1 mV and 10-50 VAC 10 mV, accuracy 1 %
- Current measuring: 0-5 A AC, best resolution 10 mA, accuracy 1 %
- Main switch with indicator light
- Dimensions: 300(W) x 150(H) mm



Note! These device modules are only compatible with BASIC workstations, see pages 70-72

EP15DYM410

Digital multimeter

- 3 ¾ digit display 3999 steps
- Basic accuracy $\pm 0.5\% + 2$ digits
- Diode measurement and continuity testing
- Hold measurement
- Relative measurement
- Duty cycle (%) measurement
- Temperature measurement with K type Thermocouple
- Backlit Facility
- Equipped with power supply
- Standard accessories: manual, cable set
- Dimensions: 100(W) x 150(H) mm



	Ranges	Best resolution	Best accuracy, \pm (a % of reading + b digits)
DC voltage	100 μ V - 1000 V	0.001 mV	0.5 % + 2
AC voltage	100 μ V - 1000 V	0.001 mV	1 % + 5
DC current	10 μ A - 10 A	0.01 μ A	0.8 % + 2
AC current	10 μ A - 10 A	0.01 μ A	1 % + 5
Resistance	100 m Ω - 40 M Ω	0.01 Ω	0.8 % + 2
Capacitance	1 pF - 200 μ F	0.001 nF	0.5 % + 3
Frequency	1 Hz - 500 kHz	0.001 Hz	0.2 % + 2
Temperature	0... +1300 $^{\circ}$ C	1 $^{\circ}$ C	2 % + 3

EP15FLUKE115

Digital multimeter

- Large white LED backlight to work in poorly lit areas
- True-rms for accurate measurements on non-linear loads
- Measures 20 A (30 seconds momentary; 10 A continuous)
- Resistance, continuity, frequency and capacitance
- Min/Max/Average to record signal fluctuations
- Battery operated
- CAT III 600 V safety rated
- Dimensions: 100(W) x 150(H) mm



	Ranges	Max. resolution	Best accuracy, \pm (a % of reading + b digits)
DC voltage	600 V	1 mV	$\pm 0.5\% + 2$
AC voltage	600 V	1 mV	$\pm 1.0\% + 3$
DC current	10 A	1 mA	$\pm 1.0\% + 3$
AC current	10 A	0.01 A	$\pm 1.5\% + 3$
Resistance	40 M Ω	0.1 Ω	$\pm 0.9\% + 1$
Capacitance	10000 μ F	1 nF	$\pm 1.9\% + 2$
Frequency	50 kHz	0.01 Hz	$\pm 0.1\% + 2$

Note! These device modules are only compatible with BASIC workstations, see pages 70-72

EP20SSLF2900

Soldering station

- Especially designed for lead-free soldering
- Power: 100 W
- $\pm 3^{\circ}\text{C}$ temperature stability
- Temperature adjustable 100-500 $^{\circ}\text{C}$
- 32 VAC hi-recovery nichrome heating
- Auto power down after 15 minutes of idling
- 45 second ramp time to max temp setting
- LCD display which shows the temperature set and the current temperature (in $^{\circ}\text{C}$)
- High quality housing ESD Safe Replaceable Soldering iron with a plug (detachable from base station)
- Pre-setting function for 3 temperatures
- All controls operate are on the LCD display screen
- Includes soldering station, soldering iron and stand for the iron
- Standard tip: SDK601
- Dimensions: 200(W) x 150(H) mm

Options

- SDKSDSERIE Tip serie, 4 pcs



EPI5GAL

Galvanometer

- Quality measurement unit for current
- Mounted separately within the device panel giving easy access for operation and connections
- Connections with 4 mm safety terminals
- Range: -50 μA ...+50 μA
- Display resolution: analogue meter
- Accuracy: $\pm 1.5 \mu\text{A}$
- Dimensions: 100(W) x 150(H) mm



EPI5DM

Digital volt- and ammeter

- Digital voltmeter
 - Quality measurement unit for DC voltage
 - Mounted separately within the device panel giving easy access for operation and connections
 - Connections with 4 mm safety terminals
 - Range: 0-20 V
 - Display resolution: 0.01 V
 - Display accuracy: $\pm 0.2 \text{ V}$
- Digital ammeter
 - Quality measurement unit for DC current
 - Mounted separately within the device panel giving easy access for operation and connections
 - Connections with 4 mm safety terminals
 - Range: 0-5 A
 - Display resolution: 0.01 A
 - Accuracy: $\pm 0.02 \text{ A}$
 - Dimensions: 150(W) x 150(H) mm





CONTACT

TEKLAB has trusted partners for our products all around the world. Please contact us to find your nearest distributor.

Teklab Oy

Telephone: +358 19 536 000

Postal Address: Länsikaari 6 A, 07900 Loviisa, Finland

E-mail: sales@teklab.fi

Website www.teklab.fi